

12

Impedance Matching

12.1 Conjugate and Reflectionless Matching

The Thévenin equivalent circuits depicted in Figs. 10.11.1 and 10.11.3 also allow us to answer the question of *maximum power transfer*. Given a generator and a length- d transmission line, maximum transfer of power from the generator to the load takes place when the load is *conjugate matched* to the generator, that is,

$$Z_L = Z_G^* \quad (\text{conjugate match}) \quad (12.1.1)$$

The proof of this result is postponed until Sec. 15.4. Writing $Z_{\text{th}} = R_{\text{th}} + jX_{\text{th}}$ and $Z_L = R_L + jX_L$, the condition is equivalent to $R_L = R_{\text{th}}$ and $X_L = -X_{\text{th}}$. In this case, half of the generated power is delivered to the load and half is dissipated in the generator's Thévenin resistance. From the Thévenin circuit shown in Fig. 10.11.1, we find for the current through the load:

$$I_L = \frac{V_{\text{th}}}{Z_{\text{th}} + Z_L} = \frac{V_{\text{th}}}{(R_{\text{th}} + R_L) + j(X_{\text{th}} + X_L)} = \frac{V_{\text{th}}}{2R_{\text{th}}}$$

Thus, the total reactance of the circuit is canceled. It follows then that the power delivered by the Thévenin generator and the powers dissipated in the generator's Thévenin resistance and the load will be:

$$P_{\text{tot}} = \frac{1}{2} \text{Re}(V_{\text{th}}^* I_L) = \frac{|V_{\text{th}}|^2}{4R_{\text{th}}} \quad (12.1.2)$$

$$P_{\text{th}} = \frac{1}{2} R_{\text{th}} |I_L|^2 = \frac{|V_{\text{th}}|^2}{8R_{\text{th}}} = \frac{1}{2} P_{\text{tot}}, \quad P_L = \frac{1}{2} R_L |I_L|^2 = \frac{|V_{\text{th}}|^2}{8R_{\text{th}}} = \frac{1}{2} P_{\text{tot}}$$

Assuming a lossless line (real-valued Z_0 and β), the conjugate match condition can also be written in terms of the reflection coefficients corresponding to Z_L and Z_{th} :

$$\Gamma_L = \Gamma_{\text{th}}^* = \Gamma_G^* e^{2j\beta d} \quad (\text{conjugate match}) \quad (12.1.3)$$

Moving the phase exponential to the left, we note that the conjugate match condition can be written in terms of the same quantities at the *input* side of the transmission line:

$$\Gamma_d = \Gamma_L e^{-2j\beta d} = \Gamma_G^* \Leftrightarrow Z_d = Z_G^* \quad (\text{conjugate match}) \quad (12.1.4)$$

Thus, the conjugate match condition can be phrased in terms of the input quantities and the equivalent circuit of Fig. 10.9.1. More generally, there is a conjugate match at *every* point along the line.

Indeed, the line can be cut at any distance l from the load and its entire left segment including the generator can be replaced by a Thévenin-equivalent circuit. The conjugate matching condition is obtained by propagating Eq. (12.1.3) to the left by a distance l , or equivalently, Eq. (12.1.4) to the right by distance $d - l$:

$$\Gamma_l = \Gamma_L e^{-2j\beta l} = \Gamma_G^* e^{2j\beta(d-l)} \quad (\text{conjugate match}) \quad (12.1.5)$$

Conjugate matching is not the same as *reflectionless matching*, which refers to matching the load to the line impedance, $Z_L = Z_0$, in order to prevent reflections from the load.

In practice, we must use *matching networks* at one or both ends of the transmission line to achieve the desired type of matching. Fig. 12.1.1 shows the two typical situations that arise.

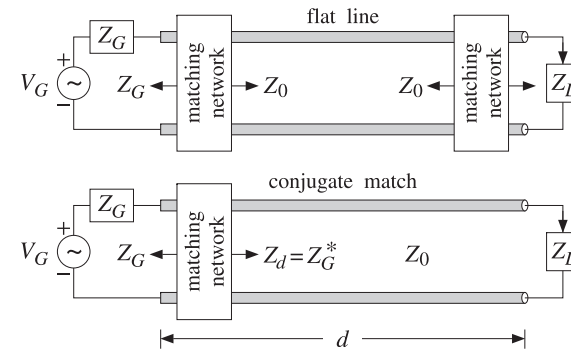

Fig. 12.1.1 Reflectionless and conjugate matching of a transmission line.

In the first, referred to as a *flat line*, both the generator and the load are matched so that effectively, $Z_G = Z_L = Z_0$. There are no reflected waves and the generator (which is typically designed to operate into Z_0) transmits maximum power to the load, as compared to the case when $Z_G = Z_0$ but $Z_L \neq Z_0$.

In the second case, the load is connected to the line without a matching circuit and the generator is conjugate-matched to the input impedance of the line, that is, $Z_d = Z_G^*$. As we mentioned above, the line remains conjugate matched everywhere along its length, and therefore, the matching network can be inserted at any convenient point, not necessarily at the line input.

Because the value of Z_d depends on Z_L and the frequency ω (through $\tan \beta d$), the conjugate match will work as designed only at a single frequency. On the other hand, if

the load and generator are purely resistive and are matched individually to the line, the matching will remain reflectionless over a larger frequency bandwidth.

Conjugate matching is usually accomplished using *L*-section reactive networks. Reflectionless matching is achieved by essentially the same methods as antireflection coating. In the next few sections, we discuss several methods for reflectionless and conjugate matching, such as (a) quarter-wavelength single- and multi-section transformers; (b) two-section series impedance transformers; (c) single, double, and triple stub tuners; and (d) *L*-section lumped-parameter reactive matching networks.

12.2 Multisection Transmission Lines

Multisection transmission lines are used primarily in the construction of broadband matching terminations. A typical multisection line is shown in Fig. 12.2.1.

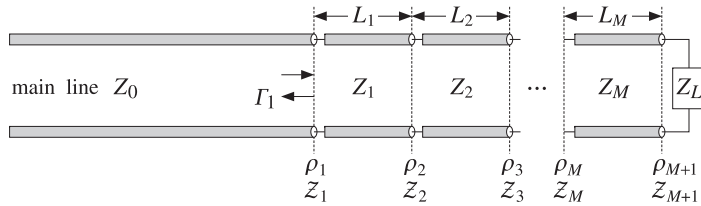

Fig. 12.2.1 Multi-section transmission line.

It consists of *M* segments between the main line and the load. The *i*th segment is characterized by its characteristic impedance *Z_i*, length *l_i*, and velocity factor, or equivalently, refractive index *n_i*. The speed in the *i*th segment is *c_i* = *c₀*/*n_i*. The phase thicknesses are defined by:

$$\delta_i = \beta_i l_i = \frac{\omega}{c_i} l_i = \frac{\omega}{c_0} n_i l_i, \quad i = 1, 2, \dots, M \tag{12.2.1}$$

We may define the electrical lengths (playing the same role as the optical lengths of dielectric slabs) in units of some reference free-space wavelength λ_0 or corresponding frequency $f_0 = c_0/\lambda_0$ as follows:

$$\text{(electrical lengths)} \quad L_i = \frac{n_i l_i}{\lambda_0} = \frac{l_i}{\lambda_i}, \quad i = 1, 2, \dots, M \tag{12.2.2}$$

where $\lambda_i = \lambda_0/n_i$ is the wavelength within the *i*th segment. Typically, the electrical lengths are quarter-wavelengths, $L_i = 1/4$. It follows that the phase thicknesses can be expressed in terms of *L_i* as $\delta_i = \omega n_i l_i / c_0 = 2\pi f n_i l_i / (f_0 \lambda_0)$, or,

$$\text{(phase thicknesses)} \quad \delta_i = \beta_i l_i = 2\pi L_i \frac{f}{f_0} = 2\pi L_i \frac{\lambda_0}{\lambda}, \quad i = 1, 2, \dots, M \tag{12.2.3}$$

where *f* is the operating frequency and $\lambda = c_0/f$ the corresponding free-space wavelength. The wave impedances, *Z_i*, are continuous across the *M* + 1 interfaces and are related by the recursions:

$$Z_i = Z_i \frac{Z_{i+1} + jZ_i \tan \delta_i}{Z_i + jZ_{i+1} \tan \delta_i}, \quad i = M, \dots, 1 \tag{12.2.4}$$

and initialized by $Z_{M+1} = Z_L$. The corresponding reflection responses at the left of each interface, $\Gamma_i = (Z_i - Z_{i-1}) / (Z_i + Z_{i-1})$, are obtained from the recursions:

$$\Gamma_i = \frac{\rho_i + \Gamma_{i+1} e^{-2j\delta_i}}{1 + \rho_i \Gamma_{i+1} e^{-2j\delta_i}}, \quad i = M, \dots, 1 \tag{12.2.5}$$

and initialized at $\Gamma_{M+1} = \Gamma_L = (Z_L - Z_M) / (Z_L + Z_M)$, where ρ_i are the elementary reflection coefficients at the interfaces:

$$\rho_i = \frac{Z_i - Z_{i-1}}{Z_i + Z_{i-1}}, \quad i = 1, 2, \dots, M + 1 \tag{12.2.6}$$

where $Z_{M+1} = Z_L$. The MATLAB function `multiline` calculates the reflection response $\Gamma_1(f)$ at interface-1 as a function of frequency. Its usage is:

```
Gamma1 = multiline(Z,L,ZL,f); % reflection response of multisection line
```

where $Z = [Z_0, Z_1, \dots, Z_M]$ and $L = [L_1, L_2, \dots, L_M]$ are the main line and segment impedances and the segment electrical lengths.

The function `multiline` implements Eq. (12.2.6) and is similar to `multidie1`, except here the load impedance Z_L is a separate input in order to allow it to be a function of frequency. We will see examples of its usage below.

12.3 Quarter-Wavelength Chebyshev Transformers

Quarter-wavelength Chebyshev impedance transformers allow the matching of real-valued load impedances Z_L to real-valued line impedances Z_0 and can be designed to achieve desired attenuation and bandwidth specifications.

The design method has already been discussed in Sec. 6.8. The results of that section translate verbatim to the present case by replacing refractive indices n_i by line admittances $Y_i = 1/Z_i$. Typical design specifications are shown in Fig. 6.8.1.

In an *M*-section transformer, all segments have equal electrical lengths, $L_i = l_i/\lambda_i = n_i l_i / \lambda_0 = 1/4$ at some operating wavelength λ_0 . The phase thicknesses of the segments are all equal and are given by $\delta_i = 2\pi L_i f / f_0$, or, because $L_i = 1/4$:

$$\delta = \frac{\pi f}{2 f_0} \tag{12.3.1}$$

The reflection response $|\Gamma_1(f)|^2$ at the left of interface-1 is expressed in terms of the order-*M* Chebyshev polynomials $T_M(x)$, where *x* is related to the phase thickness by $x = x_0 \cos \delta$:

$$|\Gamma_1(f)|^2 = \frac{e_1^2 T_M^2(x_0 \cos \delta)}{1 + e_1^2 T_M^2(x_0 \cos \delta)} \tag{12.3.2}$$

where $e_1 = e_0/T_M(x_0)$ and e_0 is given in terms of the load and main line impedances:

$$e_0^2 = \frac{(Z_L - Z_0)^2}{4Z_L Z_0} = \frac{|Γ_L|^2}{1 - |Γ_L|^2}, \quad Γ_L = \frac{Z_L - Z_0}{Z_L + Z_0} \quad (12.3.3)$$

The parameter x_0 is related to the desired reflectionless bandwidth Δf by:

$$x_0 = \frac{1}{\sin\left(\frac{\pi \Delta f}{4 f_0}\right)} \quad (12.3.4)$$

and $T_M(x_0)$ is related to the attenuation A in the reflectionless band by:

$$A = 10 \log_{10} \left(\frac{T_M^2(x_0) + e_0^2}{1 + e_0^2} \right) \quad (12.3.5)$$

Solving for M in terms of A , we have (rounding up to the next integer):

$$M = \text{ceil} \left(\frac{\text{acosh} \left(\sqrt{(1 + e_0^2) 10^{A/10} - e_0^2} \right)}{\text{acosh}(x_0)} \right) \quad (12.3.6)$$

where A is in dB and is measured from dc, or equivalently, with respect to the reflection response $|Γ_L|$ of the unmatched line. The maximum equiripple level within the reflectionless band is given by

$$|Γ_1|_{\max} = |Γ_L| 10^{-A/20} \Rightarrow A = 20 \log_{10} \left(\frac{|Γ_L|}{|Γ_1|_{\max}} \right) \quad (12.3.7)$$

This condition can also be expressed in terms of the maximum SWR within the desired bandwidth. Indeed, setting $S_{\max} = (1 + |Γ_1|_{\max}) / (1 - |Γ_1|_{\max})$ and $S_L = (1 + |Γ_L|) / (1 - |Γ_L|)$, we may rewrite (12.3.7) as follows:

$$A = 20 \log_{10} \left(\frac{|Γ_L|}{|Γ_1|_{\max}} \right) = 20 \log_{10} \left(\frac{S_L - 1}{S_L + 1} \frac{S_{\max} + 1}{S_{\max} - 1} \right) \quad (12.3.8)$$

where we must demand $S_{\max} < S_L$ or $|Γ_1|_{\max} < |Γ_L|$. The MATLAB functions `chebtr`, `chebtr2`, and `chebtr3` implement the design steps. In the present context, they have usage:

```
[Y, a, b] = chebtr(Y0, YL, A, DF); % Chebyshev multisection transformer design
[Y, a, b, A] = chebtr2(Y0, YL, M, DF); % specify order and bandwidth
[Y, a, b, DF] = chebtr3(Y0, YL, M, A); % specify order and attenuation
```

The outputs are the admittances $Y = [Y_0, Y_1, Y_2, \dots, Y_M, Y_L]$ and the reflection and transmission polynomials \mathbf{a}, \mathbf{b} . In `chebtr2` and `chebtr3`, the order M is given. The designed segment impedances $Z_i, i = 1, 2, \dots, M$ satisfy the symmetry properties:

$$Z_i Z_{M+1-i} = Z_0 Z_L, \quad i = 1, 2, \dots, M \quad (12.3.9)$$

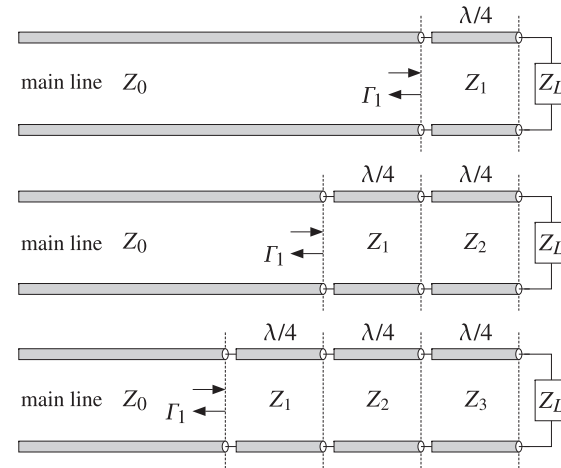

Fig. 12.3.1 One, two, and three-section quarter-wavelength transformers.

Fig. 12.3.1 depicts the three cases of $M = 1, 2, 3$ segments. The case $M = 1$ is used widely and we discuss it in more detail. According to Eq. (12.3.9), the segment impedance satisfies $Z_1^2 = Z_0 Z_L$, or,

$$Z_1 = \sqrt{Z_0 Z_L} \quad (12.3.10)$$

This implies that the reflection coefficients at interfaces 1 and 2 are equal:

$$\rho_1 = \frac{Z_1 - Z_0}{Z_1 + Z_0} = \frac{Z_L - Z_1}{Z_L + Z_1} = \rho_2 \quad (12.3.11)$$

Because the Chebyshev polynomial of order-1 is $T_1(x) = x$, the reflection response (12.3.2) takes the form:

$$|Γ_1(f)|^2 = \frac{e_0^2 \cos^2 \delta}{1 + e_0^2 \cos^2 \delta} \quad (12.3.12)$$

Using Eq. (12.3.11), we can easily verify that e_0 is related to ρ_1 by

$$e_0^2 = \frac{4\rho_1^2}{(1 - \rho_1^2)^2}$$

Then, Eq. (12.3.12) can be cast in the following equivalent form, which is recognized as the propagation of the load reflection response $Γ_2 = \rho_2 = \rho_1$ by a phase thickness δ to interface-1:

$$|Γ_1(f)|^2 = \left| \frac{\rho_1 (1 + z^{-1})}{1 + \rho_1^2 z^{-1}} \right|^2 \quad (12.3.13)$$

where $z = e^{2j\delta}$. The reflection response has a zero at $z = -1$ or $\delta = \pi/2$, which occurs at $f = f_0$ and at *odd* multiples of f_0 . The wave impedance at interface-1 will be:

$$Z_1 = Z_1 \frac{Z_L + jZ_1 \tan \delta}{Z_0 + jZ_L \tan \delta} \quad (12.3.14)$$

Using Eq. (12.3.10), we obtain the matching condition at $f = f_0$, or at $\delta = \pi/2$:

$$Z_1 = \frac{Z_1^2}{Z_L} = Z_0 \tag{12.3.15}$$

Example 12.3.1: *Single-section quarter wavelength transformer.* Design a single-section transformer that will match a 200-ohm load to a 50-ohm line at 100 MHz. Determine the bandwidth over which the SWR on the line remains less than 1.5.

Solution: The quarter-wavelength section has impedance $Z_1 = \sqrt{Z_L Z_0} = \sqrt{200 \cdot 50} = 100$ ohm. The reflection response $|T_1(f)|$ and the SWR $S(f) = (1 + |T_1(f)|) / (1 - |T_1(f)|)$ are plotted in Fig. 12.3.1 versus frequency.

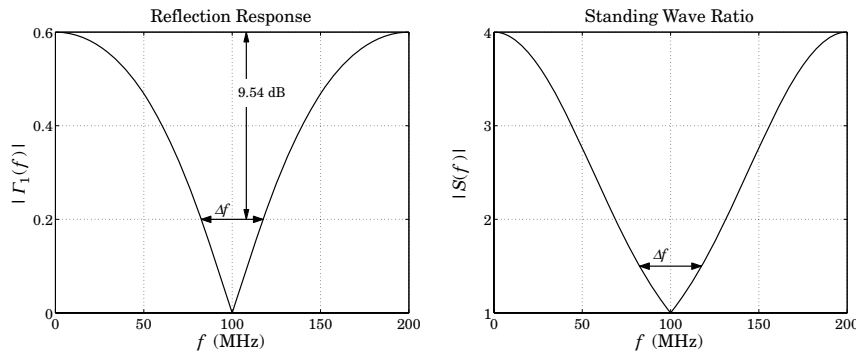

Fig. 12.3.2 Reflection response and line SWR of single-section transformer.

The reflection coefficient of the unmatched line and the maximum tolerable reflection response over the desired bandwidth are:

$$\Gamma_L = \frac{Z_L - Z_0}{Z_L + Z_0} = \frac{200 - 50}{200 + 50} = 0.6, \quad |T_1|_{\max} = \frac{S_{\max} - 1}{S_{\max} + 1} = \frac{1.5 - 1}{1.5 + 1} = 0.2$$

It follows from Eq. (12.3.7) that the attenuation in dB over the desired band will be:

$$A = 20 \log_{10} \left(\frac{|\Gamma_L|}{|T_1|_{\max}} \right) = 20 \log_{10} \left(\frac{0.6}{0.2} \right) = 9.54 \text{ dB}$$

Because the number of sections and the attenuation are fixed, we may use the MATLAB function `chebtr3`. The following code segment calculates the various design parameters:

```
Z0 = 50; ZL = 200;
GL = z2g(ZL,Z0); Smax = 1.5;

f0 = 100; f = linspace(0,2*f0,401); % plot over [0,200] MHz

A = 20*log10(GL*(Smax+1)/(Smax-1)); % Eq. (12.3.8)

[Y,a,b,DF] = chebtr3(1/Z0, 1/ZL, 1, A); % note, M = 1

Z = 1./Y; Df = f0*DF; L = 1/4; % note, Z = [Z0, Z1, ZL]
```

```
G1 = abs(multiline(Z(1:2), L, ZL, f/f0)); % reflection response |T1(f)|
S = swr(G1); % calculate SWR versus frequency

plot(f,G1); figure; plot(f,S);
```

The reflection response $|T_1(f)|$ is computed by `multiline` with frequencies normalized to the desired operating frequency of $f_0 = 100$ MHz. The impedance inputs to `multiline` were $[Z_0, Z_1]$ and Z_L and the electrical length of the segment was $L = 1/4$. The resulting bandwidth is $\Delta f = 35.1$ MHz. The reflection polynomials are:

$$\mathbf{b} = [b_0, b_1] = [\rho_1, \rho_1], \quad \mathbf{a} = [a_0, a_1] = [1, \rho_1^2], \quad \rho_1 = \frac{Z_1 - Z_0}{Z_1 + Z_0} = \frac{1}{3}$$

Two alternative ways to compute the reflection response are by using MATLAB's built-in function `freqz`, or the function `dtft`:

```
delta = pi * f/f0/2;
G1 = abs(freqz(b,a,2*delta));
% G1 = abs(dtft(b,2*delta) ./ dtft(a,2*delta));
```

where $2\delta = \pi f/f_0$ is the digital frequency, such that $z = e^{2j\delta}$. The bandwidth Δf can be computed from Eqs. (12.3.4) and (12.3.5), that is,

$$A = 10 \log_{10} \left(\frac{x_0^2 + e_0^2}{1 + e_0^2} \right) \Rightarrow x_0 = \sqrt{(1 + e_0^2) 10^{A/10} - e_0^2}, \quad \Delta f = f_0 \frac{4}{\pi} \text{asin} \left(\frac{1}{x_0} \right)$$

where we replaced $T_1(x_0) = x_0$. □

Example 12.3.2: *Three- and four-section quarter-wavelength Chebyshev transformers.* Design a Chebyshev transformer that will match a 200-ohm load to a 50-ohm line. The line SWR is required to remain less than 1.25 over the frequency band [50, 150] MHz.

Repeat the design if the SWR is required to remain less than 1.1 over the same bandwidth.

Solution: Here, we let the design specifications determine the number of sections and their characteristic impedances. In both cases, the unmatched reflection coefficient is the same as in the previous example, $\Gamma_L = 0.6$. Using $S_{\max} = 1.25$, the required attenuation in dB is for the first case:

$$A = 20 \log_{10} \left(|\Gamma_L| \frac{S_{\max} + 1}{S_{\max} - 1} \right) = 20 \log_{10} \left(0.6 \frac{1.25 + 1}{1.25 - 1} \right) = 14.65 \text{ dB}$$

The reflection coefficient corresponding to S_{\max} is $|T_1|_{\max} = (1.25 - 1) / (1.25 + 1) = 1/9 = 0.1111$. In the second case, we use $S_{\max} = 1.1$ to find $A = 22.0074$ dB and $|T_1|_{\max} = (1.1 - 1) / (1.1 + 1) = 1/21 = 0.0476$.

In both cases, the operating frequency is at the middle of the given bandwidth, that is, $f_0 = 100$ MHz. The normalized bandwidth is $\Delta f = \Delta f/f_0 = (150 - 50)/100 = 1$. With these values of $A, \Delta f$, the function `chebtr` calculates the required number of sections and their impedances. The typical code is as follows:

```

Z0 = 50; ZL = 200;
GL = z2g(ZL,Z0); Smax = 1.25;

f1 = 50; f2 = 150;           % given bandedge frequencies
Df = f2-f1; f0 = (f2+f1)/2; DF = Df/f0; % operating frequency and bandwidth

A = 20*log10(GL*(Smax+1)/(Smax-1)); % attenuation of reflectionless band

[Y,a,b] = chebtr(1/Z0, 1/ZL, A, DF); % Chebyshev transformer design

Z = 1./Y; rho = n2r(Y); % impedances and reflection coefficients

```

For the first case, the resulting number of sections is $M = 3$, and the corresponding output vector of impedances Z , reflection coefficients at the interfaces, and reflection polynomials \mathbf{a} , \mathbf{b} are:

```

Z = [Z0, Z1, Z2, Z3, ZL] = [50, 66.4185, 100, 150.5604, 200]
rho = [rho1, rho2, rho3, rho4] = [0.1410, 0.2018, 0.2018, 0.1410]
b = [b0, b1, b2, b3] = [0.1410, 0.2115, 0.2115, 0.1410]
a = [a0, a1, a2, a3] = [1, 0.0976, 0.0577, 0.0199]

```

In the second case, we find $M = 4$ sections with design parameters:

```

Z = [Z0, Z1, Z2, Z3, Z4, ZL] = [50, 59.1294, 81.7978, 122.2527, 169.1206, 200]
rho = [rho1, rho2, rho3, rho4, rho5] = [0.0837, 0.1609, 0.1983, 0.1609, 0.0837]
b = [b0, b1, b2, b3, b4] = [0.0837, 0.1673, 0.2091, 0.1673, 0.0837]
a = [a0, a1, a2, a3, a4] = [1, 0.0907, 0.0601, 0.0274, 0.0070]

```

The reflection responses and SWRs are plotted versus frequency in Fig. 12.3.3. The upper two graphs corresponds to the case, $S_{\max} = 1.25$, and the bottom two graphs, to the case $S_{\max} = 1.1$.

The reflection responses $|\Gamma_1(f)|$ can be computed either with the help of the function `multiline`, or as the ratio of the reflection polynomials:

$$\Gamma_1(z) = \frac{b_0 + b_1 z^{-1} + \dots + b_M z^{-M}}{a_0 + a_1 z^{-1} + \dots + a_M z^{-M}}, \quad z = e^{2j\delta}, \quad \delta = \frac{\pi f}{2 f_0}$$

The typical MATLAB code for producing these graphs uses the outputs of `chebtr`:

```

f = linspace(0,2*f0,401); % plot over [0,200] MHz

M = length(Z)-2; % number of sections
L = ones(1,M)/4; % quarter-wave lengths
G1 = abs(multiline(Z(1:M+1), L, ZL, f/f0)); % ZL is a separate input

G1 = abs(freqz(b, a, pi*f/f0)); % alternative way of computing G1

S = swr(G1); % SWR on the line

plot(f,G1); figure; plot(f,S);

```

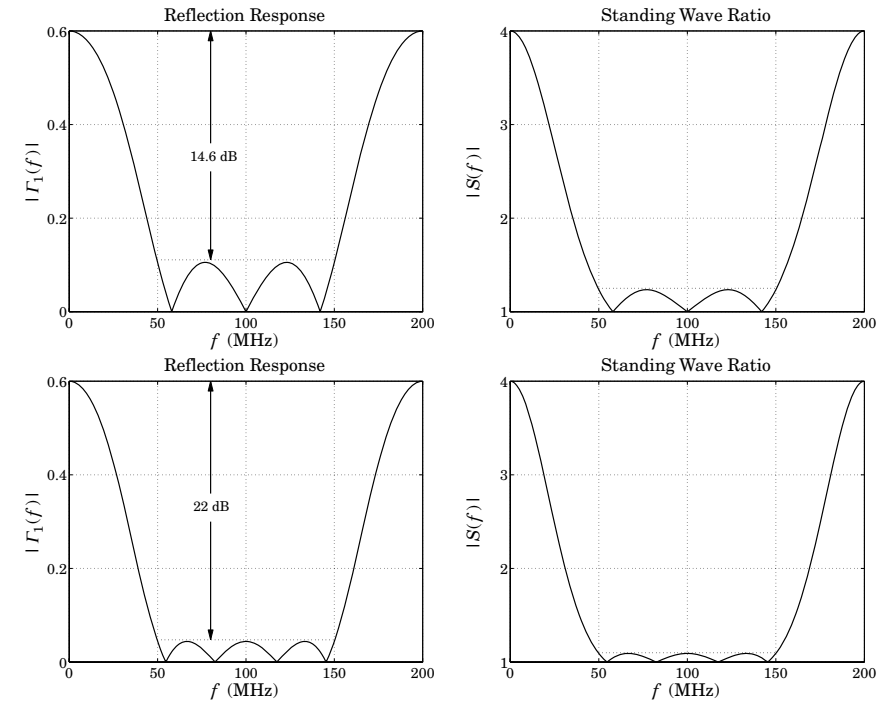

Fig. 12.3.3 Three and four section transformers.

In both cases, the section impedances satisfy the symmetry properties (12.3.9) and the reflection coefficients ρ are symmetric about their middle, as discussed in Sec. 6.8.

We note that the reflection coefficients ρ_i at the interfaces agree fairly closely with the reflection polynomial \mathbf{b} —equating the two is equivalent to the so-called *small-reflection approximation* that is usually made in designing quarter-wavelength transformers [805]. The above values are exact and do not depend on any approximation. \square

12.4 Two-Section Dual-Band Chebyshev Transformers

Recently, a two-section sixth-wavelength transformer has been designed [976,977] that achieves matching at a frequency f_1 and its first harmonic $2f_1$. Each section has length $\lambda/6$ at the design frequency f_1 . Such dual-band operation is desirable in certain applications, such as GSM and PCS systems. The transformer is depicted in Fig. 12.4.1.

Here, we point out that this design is actually equivalent to a two-section quarter-wavelength Chebyshev transformer whose parameters have been adjusted to achieve reflectionless notches at both frequencies f_1 and $2f_1$.

Using the results of the previous section, a two-section Chebyshev transformer will have reflection response:

$$|\Gamma_1(f)|^2 = \frac{e_1^2 T_2^2(x_0 \cos \delta)}{1 + e_1^2 T_2^2(x_0 \cos \delta)}, \quad \delta = \frac{\pi f}{2 f_0} \quad (12.4.1)$$

where f_0 is the frequency at which the sections are quarter-wavelength. The second-order Chebyshev polynomial is $T_2(x) = 2x^2 - 1$ and has roots at $x = \pm 1/\sqrt{2}$. We require that these two roots correspond to the frequencies f_1 and $2f_1$, that is, we set:

$$x_0 \cos \delta_1 = \frac{1}{\sqrt{2}}, \quad x_0 \cos 2\delta_1 = -\frac{1}{\sqrt{2}}, \quad \delta_1 = \frac{\pi f_1}{2 f_0} \quad (12.4.2)$$

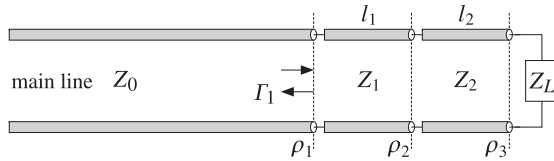

Fig. 12.4.1 Two-section dual-band Chebyshev transformer.

These conditions have the unique solution (such that $x_0 \geq 1$):

$$x_0 = \sqrt{2}, \quad \delta_1 = \frac{\pi}{3} = \frac{\pi f_1}{2 f_0} \Rightarrow f_0 = \frac{3}{2} f_1 \quad (12.4.3)$$

Thus, at f_1 the phase length is $\delta_1 = \pi/3 = 2\pi/6$, which corresponds to section lengths of $l_1 = l_2 = \lambda_1/6$, where $\lambda_1 = v/f_1$, and v is the propagation speed. Defining also $\lambda_0 = v/f_0$, we note that $\lambda_0 = 2\lambda_1/3$. According to Sec. 6.6, the most general two-section reflection response is expressed as the ratio of the second-order polynomials:

$$\Gamma_1(f) = \frac{B_1(z)}{A_1(z)} = \frac{\rho_1 + \rho_2(1 + \rho_1\rho_3)z^{-1} + \rho_3z^{-2}}{1 + \rho_2(\rho_1 + \rho_3)z^{-1} + \rho_1\rho_3z^{-2}} \quad (12.4.4)$$

where

$$z = e^{2j\delta}, \quad \delta = \frac{\pi f}{2 f_0} = \frac{\pi f}{3 f_1} \quad (12.4.5)$$

and we used the relationship $2f_0 = 3f_1$ to express δ in terms of f_1 . The polynomial $B_1(z)$ must have zeros at $z = e^{2j\delta_1} = e^{2\pi j/3}$ and $z = e^{2j(2\delta_1)} = e^{4\pi j/3} = e^{-2\pi j/3}$, hence, it must be (up to the factor ρ_1):

$$B_1(z) = \rho_1(1 - e^{2\pi j/3}z^{-1})(1 - e^{-2\pi j/3}z^{-1}) = \rho_1(1 + z^{-1} + z^{-2}) \quad (12.4.6)$$

Comparing this with (12.4.4), we arrive at the conditions:

$$\rho_3 = \rho_1, \quad \rho_2(1 + \rho_1\rho_3) = \rho_1 \Rightarrow \rho_2 = \frac{\rho_1}{1 + \rho_1^2} \quad (12.4.7)$$

We recall from the previous section that the condition $\rho_1 = \rho_3$ is equivalent to $Z_1Z_2 = Z_0Z_L$. Using (12.4.7) and the definition $\rho_2 = (Z_2 - Z_1)/(Z_2 + Z_1)$, or its inverse, $Z_2 = Z_1(1 + \rho_2)/(1 - \rho_2)$, we have:

$$Z_LZ_0 = Z_1Z_2 = Z_1^2 \frac{1 + \rho_2}{1 - \rho_2} = Z_1^2 \frac{\rho_1^2 + \rho_1 + 1}{\rho_1^2 - \rho_1 + 1} = Z_1^2 \frac{3Z_1^2 + Z_0^2}{Z_1^2 + 3Z_0^2} \quad (12.4.8)$$

where in the last equation, we replaced $\rho_1 = (Z_1 - Z_0)/(Z_1 + Z_0)$. This gives a quadratic equation in Z_1^2 . Picking the positive solution of the quadratic equation, we find:

$$Z_1 = \sqrt{\frac{Z_0}{6} \left[Z_L - Z_0 + \sqrt{(Z_L - Z_0)^2 + 36Z_LZ_0} \right]} \quad (12.4.9)$$

Once Z_1 is known, we may compute $Z_2 = Z_LZ_0/Z_1$. Eq. (12.4.9) is equivalent to the expression given by Monzon [977].

The sections are quarter-wavelength at f_0 and sixth-wavelength at f_1 , that is, $l_1 = l_2 = \lambda_1/6 = \lambda_0/4$. We note that the frequency f_0 lies exactly in the middle between f_1 and $2f_1$. Viewed as a quarter-wavelength transformer, the bandwidth will be:

$$\sin\left(\frac{\pi \Delta f}{4 f_0}\right) = \frac{1}{x_0} = \frac{1}{\sqrt{2}} \Rightarrow \Delta f = f_0 = 1.5f_1 \quad (12.4.10)$$

which spans the interval $[f_0 - \Delta f/2, f_0 + \Delta f/2] = [0.75f_1, 2.25f_1]$. Using $T_2(x_0) = 2x_0^2 - 1 = 3$ and Eq. (12.3.6), we find the attenuation achieved over the bandwidth Δf :

$$\sqrt{(1 + e_0^2)10^{A/10} - e_0^2} = T_2(x_0) = 3 \Rightarrow A = 10 \log_{10} \left(\frac{9 + e_0^2}{1 + e_0^2} \right) \quad (12.4.11)$$

As an example, we consider the matching of $Z_L = 200 \Omega$ to $Z_0 = 50 \Omega$. The section impedances are found from Eq. (12.4.9) to be: $Z_1 = 80.02 \Omega$, $Z_2 = 124.96 \Omega$. More simply, we can invoke the function `chebtr2` with $M = 2$ and $\Delta F = \Delta f/f_0 = 1$.

Fig. 12.4.2 shows the designed reflection response normalized to its dc value, that is, $|\Gamma_1(f)|^2/|\Gamma_1(0)|^2$. The response has exact zeros at f_1 and $2f_1$. The attenuation was $A = 7.9$ dB. The reflection coefficients were $\rho_1 = \rho_3 = 0.2309$ and $\rho_2 = \rho_1/(1 + \rho_1^2) = 0.2192$, and the reflection polynomials:

$$B_1(z) = 0.2309(1 + z^{-1} + z^{-2}), \quad A_1(z) = 1 + 0.1012z^{-1} + 0.0533z^{-2}$$

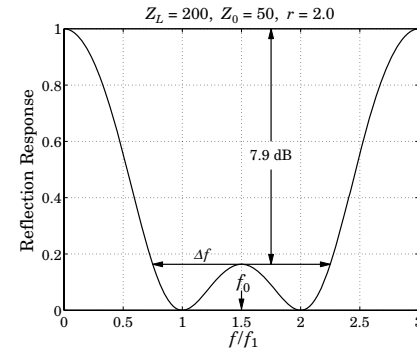

Fig. 12.4.2 Reflection response $|\Gamma_1(f)|^2$ normalized to unity gain at dc.

The reflection response can be computed using Eq. (12.4.1), or using the MATLAB function `multiline`, or the function `freqz` and the computed polynomial coefficients. The following code illustrates the computation using `chebtr2`:

```

Z0 = 50; ZL = 100; x0 = sqrt(2); e0sq = (ZL-Z0)^2/(4*ZL*Z0); e1sq = e0sq/9;

[Y,a1,b1,A] = chebtr2(1/Z0, 1/ZL, 2, 1); % a1 = [1, 0.1012, 0.0533]
% b1 = [0.2309, 0.2309, 0.2309]
Z = 1./Y; rho = n2r(Z0*Y); % Z = [50, 80.02, 124.96, 200]
% rho = [0.2309, 0.2192, 0.2309]
% f is in units of f1

f = linspace(0,3,301);
delta = pi*f/3; x = x0*cos(delta); T2 = 2*x.^2-1;

G1 = e1sq*T2.^2 ./ (1 + e1sq*T2.^2);

% G1 = abs(multiline(Z(1:3), [1,1]/6, ZL, f)).^2; % alternative calculation
% G1 = abs(freqz(b1,a1, 2*delta)).^2; % alternative calculation
% G1 = abs(dtf(b1,2*delta)/dtf(a1,2*delta)).^2; % alternative calculation

plot(f, G1/G1(1));

```

The above design method is not restricted to the first and second harmonics. It can be generalized to any two frequencies f_1, f_2 at which the two-section transformer is required to be reflectionless [978,979].

Possible applications are the matching of dual-band antennas operating in the cellular/PCS, GSM/DCS, WLAN, GPS, and ISM bands, and other dual-band RF applications for which the frequency f_2 is not necessarily $2f_1$.

We assume that $f_1 < f_2$, and define $r = f_2/f_1$, where r can take any value greater than unity. The reflection polynomial $B_1(z)$ is constructed to have zeros at f_1, f_2 :

$$B_1(z) = \rho_1(1 - e^{2j\delta_1}z^{-1})(1 - e^{2j\delta_2}z^{-1}), \quad \delta_1 = \frac{\pi f_1}{2f_0}, \quad \delta_2 = \frac{\pi f_2}{2f_0} \quad (12.4.12)$$

The requirement that the segment impedances, and hence the reflection coefficients ρ_1, ρ_2, ρ_3 , be real-valued implies that the zeros of $B_1(z)$ must be conjugate pairs. This can be achieved by choosing the quarter-wavelength normalization frequency f_0 to lie half-way between f_1, f_2 , that is, $f_0 = (f_1 + f_2)/2 = (r + 1)f_1/2$. This implies that:

$$\delta_1 = \frac{\pi}{r+1}, \quad \delta_2 = r\delta_1 = \pi - \delta_1 \quad (12.4.13)$$

The phase length at any frequency f will be:

$$\delta = \frac{\pi f}{2f_0} = \frac{\pi f}{r+1f_1} \quad (12.4.14)$$

The section lengths become quarter-wavelength at f_0 and $2(r+1)$ -th wavelength at f_1 :

$$l_1 = l_2 = \frac{\lambda_0}{4} = \frac{\lambda_1}{2(r+1)} \quad (12.4.15)$$

It follows now from Eq. (12.4.13) that the zeros of $B_1(z)$ are complex-conjugate pairs:

$$e^{2j\delta_2} = e^{2j(\pi-\delta_1)} = e^{-2j\delta_1} \quad (12.4.16)$$

Then, $B_1(z)$ takes the form:

$$B_1(z) = \rho_1(1 - e^{2j\delta_1}z^{-1})(1 - e^{-2j\delta_1}z^{-1}) = \rho_1(1 - 2\cos 2\delta_1 z^{-1} + z^{-2}) \quad (12.4.17)$$

Comparing with Eq. (12.4.4), we obtain the reflection coefficients:

$$\rho_3 = \rho_1, \quad \rho_2 = -\frac{2\rho_1 \cos 2\delta_1}{1 + \rho_1^2} \quad (12.4.18)$$

Proceeding as in (12.4.8) and using the identity $\tan^2 \delta_1 = (1 - \cos 2\delta_1)/(1 + \cos 2\delta_1)$, we find the following equation for the impedance Z_1 of the first section:

$$Z_L Z_0 = Z_1 Z_2 = Z_1^2 \frac{1 + \rho_2}{1 - \rho_2} = Z_1^2 \frac{\rho_1^2 - 2\rho_1 \cos 2\delta_1 + 1}{\rho_1^2 + 2\rho_1 \cos 2\delta_1 + 1} = Z_1^2 \frac{Z_1^2 \tan^2 \delta_1 + Z_0^2}{Z_1^2 + Z_0^2 \tan^2 \delta_1} \quad (12.4.19)$$

with solution for Z_1 and Z_2 :

$$Z_1 = \sqrt{\frac{Z_0}{2 \tan^2 \delta_1} \left[Z_L - Z_0 + \sqrt{(Z_L - Z_0)^2 + 4Z_L Z_0 \tan^4 \delta_1} \right]}, \quad Z_2 = \frac{Z_0 Z_L}{Z_1} \quad (12.4.20)$$

Equations (12.4.13), (12.4.15), and (12.4.20) provide a complete solution to the two-section transformer design problem. The design equations have been implemented by the MATLAB function `dua1band`:

$$[Z1, Z2, a1, b1] = \text{dua1band}(Z0, ZL, r); \quad \% \text{two-section dual-band Chebyshev transformer}$$

where $\mathbf{a}_1, \mathbf{b}_1$ are the coefficients of $A_1(z)$ and $B_1(z)$. Next, we show that $B_1(z)$ is indeed proportional to the Chebyshev polynomial $T_2(x)$. Setting $z = e^{2j\delta}$, where δ is given by (12.4.14), we find:

$$\begin{aligned} B_1(z) &= \rho_1(z + z^{-1} - 2\cos 2\delta_1)z^{-1} = \rho_1(2\cos 2\delta - 2\cos 2\delta_1)e^{-2j\delta} \\ &= 4\rho_1(\cos^2 \delta - \cos^2 \delta_1)e^{-2j\delta} = 4\rho_1 \cos^2 \delta_1 \left(\frac{\cos^2 \delta}{\cos^2 \delta_1} - 1 \right) e^{-2j\delta} \\ &= 4\rho_1 \cos^2 \delta_1 (2x_0^2 \cos^2 \delta - 1)e^{-2j\delta} = 4\rho_1 \cos^2 \delta_1 T_2(x_0 \cos \delta) e^{-2j\delta} \end{aligned} \quad (12.4.21)$$

where we defined:

$$x_0 = \frac{1}{\sqrt{2} \cos \delta_1} \quad (12.4.22)$$

We may also show that the reflection response $|\Gamma_1(f)|^2$ is given by Eq. (12.4.1). At zero frequency, $\delta = 0$, we have $T_2(x_0) = 2x_0^2 - 1 = \tan^2 \delta_1$. As discussed in Sec. 6.8, the sum of the coefficients of the polynomial $B_1(z)$, or equivalently, its value at dc, $\delta = 0$ or $z = 1$, must be given by $|B_1(1)|^2 = \sigma^2 e_0^2$, where

$$\sigma^2 = (1 - \rho_1^2)(1 - \rho_2^2)(1 - \rho_3^2), \quad e_0^2 = \frac{(Z_L - Z_0)^2}{4Z_L Z_0} \quad (12.4.23)$$

Using Eq. (12.4.21), this condition reads $\sigma^2 e_0^2 = |B_1(1)|^2 = 16\rho_1^2 \cos^4 \delta_1 T_2^2(x_0)$, or, $\sigma^2 e_0^2 = 16\rho_1^2 \sin^4 \delta_1$. This can be verified with some tedious algebra. Because $e_1^2 = e_0^2/T_2^2(x_0)$, the same condition reads $\sigma^2 e_1^2 = 16\rho_1^2 \cos^4 \delta_1$.

It follows that $|B_1(z)|^2 = \sigma^2 e_1^2 T_2^2(x)$. On the other hand, according to Sec. 6.6, the denominator polynomial $A_1(z)$ in (12.4.4) satisfies $|A_1(z)|^2 - |B_1(z)|^2 = \sigma^2$, or, $|A_1(z)|^2 = \sigma^2 + |B_1(z)|^2$. Therefore,

$$|\Gamma_1(f)|^2 = \frac{|B_1(z)|^2}{|A_1(z)|^2} = \frac{|B_1(z)|^2}{\sigma^2 + |B_1(z)|^2} = \frac{\sigma^2 e_1^2 T_2^2(x)}{\sigma^2 + \sigma^2 e_1^2 T_2^2(x)} = \frac{e_1^2 T_2^2(x)}{1 + e_1^2 T_2^2(x)} \quad (12.4.24)$$

Thus, the reflectance is identical to that of a two-section Chebyshev transformer. However, the interpretation as a quarter-wavelength transformer, that is, a transformer whose attenuation at f_0 is less than the attenuation at dc, is valid only for a limited range of values, that is, $1 \leq r \leq 3$. For this range, the parameter x_0 defined in (12.4.22) is $x_0 \geq 1$. In this case, the corresponding bandwidth about f_0 can be meaningfully defined through Eq. (12.3.4), which gives:

$$\sin\left(\frac{\pi}{2(r+1)}\frac{\Delta f}{f_1}\right) = \sqrt{2} \cos \delta_1 = \sqrt{2} \cos\left(\frac{\pi}{r+1}\right) \tag{12.4.25}$$

For $1 \leq r \leq 3$, the right-hand side is always less than unity. On the other hand, when $r > 3$, the parameter x_0 becomes $x_0 < 1$, the bandwidth Δf loses its meaning, and the reflectance at f_0 becomes greater than that at dc, that is, a gain. For any value of r , the attenuation or gain at f_0 can be calculated from Eq. (12.3.5) with $M = 2$:

$$A = 10 \log_{10} \left(\frac{T_2^2(x_0) + e_0^2}{1 + e_0^2} \right) = 10 \log_{10} \left(\frac{\tan^4 \delta_1 + e_0^2}{1 + e_0^2} \right) \tag{12.4.26}$$

The quantity A is positive for $1 < r < 3$ or $\tan \delta_1 > 1$, and negative for $r > 3$ or $\tan \delta_1 < 1$. For the special case of $r = 3$, we have $\delta_1 = \pi/4$ and $\tan \delta_1 = 1$, which gives $A = 0$. Also, it follows from (12.4.18) that $\rho_2 = 0$, which means that $Z_1 = Z_2$ and (12.4.19) gives $Z_1^2 = Z_L Z_0$. The two sections combine into a single section of double length $2l_1 = \lambda_1/4$ at f_1 , that is, a single-section quarter wavelength transformer, which, as is well known, has zeros at odd multiples of its fundamental frequency.

For the case $r = 2$, we have $\delta_1 = \pi/3$ and $\tan \delta_1 = \sqrt{3}$. The design equation (12.4.20) reduces to that given in [977] and the section lengths become $\lambda_1/6$.

Fig. 12.4.3 shows two examples, one with $r = 2.5$ and one with $r = 3.5$, both transforming $Z_L = 200$ into $Z_0 = 50$ ohm.

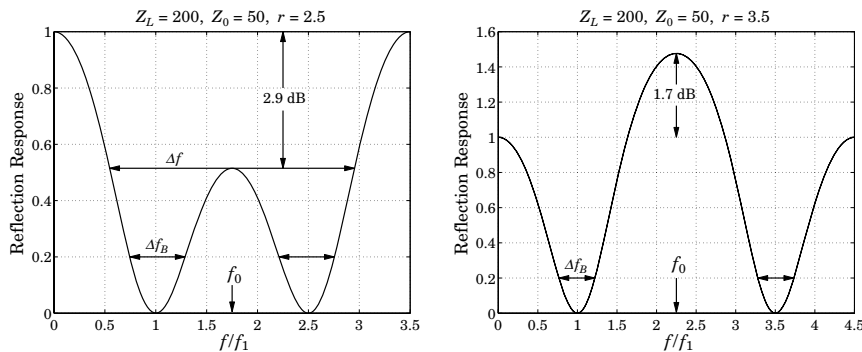

Fig. 12.4.3 Dual-band transformers at frequencies $\{f_1, 2.5f_1\}$ and $\{f_1, 3.5f_1\}$.

The reflectances are normalized to unity gain at dc. For $r = 2.5$, we find $Z_1 = 89.02$ and $Z_2 = 112.33$ ohm, and attenuation $A = 2.9$ dB. The section lengths at f_1 are $l_1 = l_2 = \lambda_1 / (2(2.5 + 1)) = \lambda_1/7$. The bandwidth Δf calculated from Eq. (12.4.25) is shown

on the left graph. For the case $r = 3.5$, we find $Z_1 = 112.39$ and $Z_2 = 88.98$ ohm and section lengths $l_1 = l_2 = \lambda_1/9$. The quantity A is negative, $A = -1.7$ dB, signifying a gain at f_0 . The polynomial coefficients were in the two cases:

$$\begin{aligned} r = 2.5, \quad \mathbf{a}_1 &= [1, 0.0650, 0.0788], \quad \mathbf{b}_1 = [0.2807, 0.1249, 0.2807] \\ r = 3.5, \quad \mathbf{a}_1 &= [1, -0.0893, 0.1476], \quad \mathbf{b}_1 = [0.3842, -0.1334, 0.3842] \end{aligned}$$

The bandwidth about f_1 and f_2 corresponding to any desired bandwidth level can be obtained in closed form. Let Γ_B be the desired bandwidth level. Equivalently, Γ_B can be determined from a desired SWR level S_B through $\Gamma_B = (S_B - 1) / (S_B + 1)$. The bandedge frequencies can be derived from Eq. (12.4.24) by setting:

$$|\Gamma_1(f)|^2 = \Gamma_B^2$$

Solving this equation, we obtain the left and right bandedge frequencies:

$$\begin{aligned} f_{1L} &= \frac{2f_0}{\pi} \text{asin}(\sqrt{1-a} \sin \delta_1), & f_{2R} &= 2f_0 - f_{1L} \\ f_{1R} &= \frac{2f_0}{\pi} \text{asin}(\sqrt{1+a} \sin \delta_1), & f_{2L} &= 2f_0 - f_{1R} \end{aligned} \tag{12.4.27}$$

where $f_0 = (f_1 + f_2)/2$ and a is defined in terms of Γ_B and Γ_L by:

$$a = \left[\frac{\Gamma_B^2}{1 - \Gamma_B^2} \frac{1 - \Gamma_L^2}{\Gamma_L^2} \right]^{1/2} = \frac{S_B - 1}{S_L - 1} \sqrt{\frac{S_L}{S_B}} \tag{12.4.28}$$

where $\Gamma_L = (Z_L - Z_0) / (Z_L + Z_0)$ and $S_L = (1 + |\Gamma_L|) / (1 - |\Gamma_L|)$. We note the symmetry relations: $f_{1L} + f_{2R} = f_{1R} + f_{2L} = 2f_0$. These imply that the bandwidths about f_1 and f_2 are the same:

$$\Delta f_B = f_{1R} - f_{1L} = f_{2R} - f_{2L} \tag{12.4.29}$$

The MATLAB function `duallbw` implements Eqs. (12.4.27):

```
[f1L, f1R, f2L, f2R] = duallbw(ZL, Z0, r, GB); % bandwidths of dual-band transformer
```

The bandwidth Δf_B is shown in Fig. 12.4.3. For illustration purposes, it was computed at a level such that $\Gamma_B^2 / \Gamma_L^2 = 0.2$.

12.5 Quarter-Wavelength Transformer With Series Section

One limitation of the Chebyshev quarter-wavelength transformer is that it requires the load to be real-valued. The method can be modified to handle complex loads, but generally the wide bandwidth property is lost. The modification is to insert the quarter-wavelength transformer not at the load, but at a distance from the load corresponding to a voltage minimum or maximum.

For example, Fig. 12.5.1 shows the case of a single quarter-wavelength section inserted at a distance L_{\min} from the load. At that point, the wave impedance seen by the quarter-wave transformer will be real-valued and given by $Z_{\min} = Z_0 / S_L$, where S_L is the

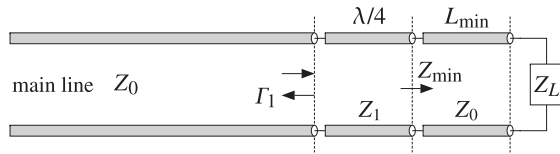

Fig. 12.5.1 Quarter-wavelength transformer for matching a complex load.

SWR of the unmatched load. Alternatively, one can choose a point of voltage maximum L_{max} at which the wave impedance will be $Z_{max} = Z_0 S_L$.

As we saw in Sec. 10.13, the electrical lengths L_{min} or L_{max} are related to the phase angle θ_L of the load reflection coefficient Γ_L by Eqs. (10.13.2) and (10.13.3). The MATLAB function `lmin` can be called to calculate these distances and corresponding wave impedances.

The calculation of the segment length, L_{min} or L_{max} , depends on the desired matching frequency f_0 . Because a complex impedance can vary rapidly with frequency, the segment will have the wrong length at other frequencies.

Even if the segment is followed by a multisection transformer, the presence of the segment will tend to restrict the overall operating bandwidth to essentially that of a single quarter-wavelength section. In the case of a single section, its impedance can be calculated simply as:

$$Z_1 = \sqrt{Z_0 Z_{min}} = \frac{1}{\sqrt{S_L}} Z_0 \quad \text{and} \quad Z_1 = \sqrt{Z_0 Z_{max}} = \sqrt{S_L} Z_0 \quad (12.5.1)$$

Example 12.5.1: *Quarter-wavelength matching of a complex load impedance.* Design a quarter-wavelength transformer of length $M = 1, 3, 5$ that will match the complex impedance $Z_L = 200 + j100$ ohm to a 50-ohm line at $f_0 = 100$ MHz. Perform the design assuming the maximum reflection coefficient level of $|\Gamma_1|_{max} = 0.1$.

Assuming that the inductive part of Z_L arises from an inductance, replace the complex load by $Z_L = 200 + j100f/f_0$ at other frequencies. Plot the corresponding reflection response $|\Gamma_1(f)|$ versus frequency.

Solution: At f_0 , the load is $Z_L = 200 + j100$ and its reflection coefficient and SWR are found to be $|\Gamma_L| = 0.6695$ and $S_L = 5.0521$. It follows that the line segments corresponding to a voltage minimum and maximum will have parameters:

$$L_{min} = 0.2665, \quad Z_{min} = \frac{1}{S_L} Z_0 = 9.897, \quad L_{max} = 0.0165, \quad Z_{max} = S_L Z_0 = 252.603$$

For either of these cases, the effective load reflection coefficient seen by the transformer will be $|\Gamma| = (S_L - 1) / (S_L + 1) = 0.6695$. It follows that the design attenuation specification for the transformer will be:

$$A = 20 \log_{10} \left(\frac{|\Gamma|}{|\Gamma_1|_{max}} \right) = 20 \log_{10} \left(\frac{0.6695}{0.1} \right) = 16.5155 \text{ dB}$$

With the given number of sections M and this value of the attenuation A , the following MATLAB code will design the transformer and calculate the reflection response of the overall structure:

```
Z0 = 50; ZL0 = 200 + 100j; % load impedance at f0
[Lmin, Zmin] = lmin(ZL0,Z0,'min'); % calculate Lmin
Gmin = abs(z2g(Zmin,Z0)); G1max = 0.1; % design based on Zmin
A = 20*log10(Gmin/G1max);

M = 3; % three-section transformer
Z = 1./chebtr3(1/Z0, 1/Zmin, M, A); % concatenate all sections
Ztot = [Z(1:M+1), Z0]; % electrical lengths of all sections
Ltot = [ones(1,M)/4, Lmin];

f0 = 100; f = linspace(0,2*f0, 801);
ZL = 200 + j*100*f/f0; % assume inductive load

G1 = abs(multiline(Ztot, Ltot, ZL, f/f0)); % overall reflection response
```

where the designed impedances and quarter-wavelength segments are concatenated with the last segment of impedance Z_0 and length L_{min} or L_{max} . The corresponding frequency reflection responses are shown in Fig. 12.5.2.

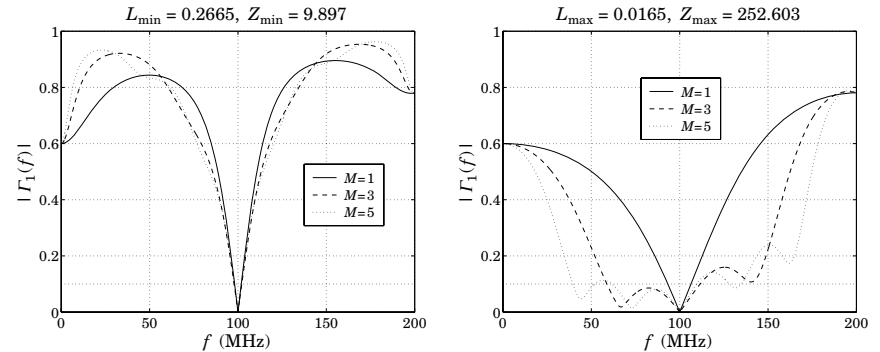

Fig. 12.5.2 Matching a complex impedance.

The calculated vector outputs of the transformer impedances are in the L_{min} case:

$$Z = [50, 50/S_L^{1/2}, 50/S_L] = [50, 22.2452, 9.897]$$

$$Z = [50, 36.5577, 22.2452, 13.5361, 9.897]$$

$$Z = [50, 40.5325, 31.0371, 22.2452, 15.9437, 12.2087, 9.897]$$

and in the L_{max} case:

$$Z = [50, 50 S_L^{1/2}, 50 S_L] = [50, 112.3840, 252.603]$$

$$Z = [50, 68.3850, 112.3840, 184.6919, 252.603]$$

$$Z = [50, 61.6789, 80.5486, 112.3840, 156.8015, 204.7727, 252.603]$$

We note that there is essentially no difference in bandwidth over the desired design level of $|\Gamma_1|_{max} = 0.1$ in the L_{min} case, and very little difference in the L_{max} case. □

The MATLAB function `qwt1` implements this matching method. Its inputs are the complex load and line impedances Z_L , Z_0 and its outputs are the quarter-wavelength section impedance Z_1 and the electrical length L_m of the Z_0 -section. It has usage:

```
[Z1, Lm] = qwt1(ZL, Z0, type); % λ/4-transformer with series section
```

where `type` is one of the strings 'min' or 'max', depending on whether the first section gives a voltage minimum or maximum.

12.6 Quarter-Wavelength Transformer With Shunt Stub

Two other possible methods of matching a complex load are to use a shorted or opened stub connected in parallel with the load and adjusting its length or its line impedance so that its susceptance cancels the load susceptance, resulting in a real load that can then be matched by the quarter-wave section.

In the first method, the stub length is chosen to be either $\lambda/8$ or $3\lambda/8$ and its impedance is determined in order to provide the required cancellation of susceptance.

In the second method, the stub's characteristic impedance is chosen to have a convenient value and its length is determined in order to provide the susceptance cancellation.

These methods are shown in Fig. 12.6.1. In practice, they are mostly used with microstrip lines that have easily adjustable impedances. The methods are similar to the stub matching methods discussed in Sec. 12.8 in which the stub is not connected at the load but rather after the series segment.

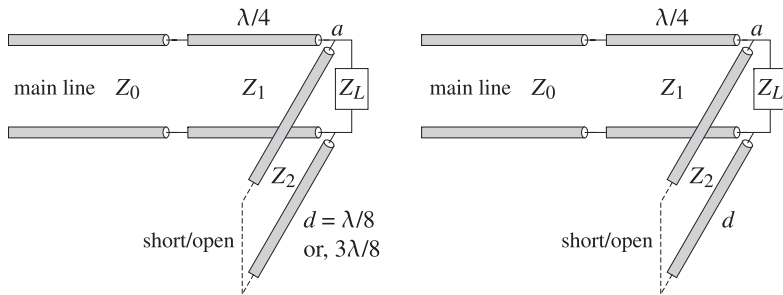

Fig. 12.6.1 Matching with a quarter-wavelength section and a shunt stub.

Let $Y_L = 1/Z_L = G_L + jB_L$ be the load admittance. The admittance of a shorted stub of characteristic admittance $Y_2 = 1/Z_2$ and length d is $Y_{\text{stub}} = -jY_2 \cot \beta d$ and that of an opened stub, $Y_{\text{stub}} = jY_2 \tan \beta d$.

The total admittance at point a in Fig. 12.6.1 is required to be real-valued, resulting in the susceptance cancellation condition:

$$Y_a = Y_L + Y_{\text{stub}} = G_L + j(B_L - Y_2 \cot \beta d) = G_L \Rightarrow Y_2 \cot \beta d = B_L \quad (12.6.1)$$

For an opened stub the condition becomes $Y_2 \tan \beta d = -B_L$. In the first method, the stub length is $d = \lambda/8$ or $3\lambda/8$ with phase thicknesses $\beta d = \pi/4$ or $3\pi/4$. The

corresponding values of the cotangents and tangents are $\cot \beta d = \tan \beta d = 1$ or $\cot \beta d = \tan \beta d = -1$.

Then, the susceptance cancellation condition becomes $Y_2 = B_L$ for a shorted $\lambda/8$ -stub or an opened $3\lambda/8$ -stub, and $Y_2 = -B_L$ for a shorted $3\lambda/8$ -stub or an opened $\lambda/8$ -stub. The case $Y_2 = B_L$ must be chosen when $B_L > 0$ and $Y_2 = -B_L$, when $B_L < 0$.

In the second method, Z_2 is chosen and the length d is determined from the condition (12.6.1), $\cot \beta d = B_L/Y_2 = Z_2 B_L$ for a shorted stub, and $\tan \beta d = -Z_2 B_L$ for an opened one. The resulting d must be reduced modulo $\lambda/2$ to a positive value.

With the cancellation of the load susceptance, the impedance looking to the right of point a will be real-valued, $Z_a = 1/Y_a = 1/G_L$. Therefore, the quarter-wavelength section will have impedance:

$$Z_1 = \sqrt{Z_0 Z_a} = \sqrt{\frac{Z_0}{G_L}} \quad (12.6.2)$$

The MATLAB functions `qwt2` and `qwt3` implement the two matching methods. Their usage is as follows:

```
[Z1, Z2] = qwt2(ZL, Z0); % λ/4-transformer with λ/8 shunt stub
[Z1, d] = qwt3(ZL, Z0, Z2, type) % λ/4-transformer with shunt stub of given impedance
```

where `type` takes on the string values 's' or 'o' for shorted or opened stubs.

Example 12.6.1: Design quarter-wavelength matching circuits to match the load impedance $Z_L = 15 + 20j \Omega$ to a 50-ohm generator at 5 GHz using series sections and shunt stubs. Use microstrip circuits with a Duroid substrate ($\epsilon_r = 2.2$) of height $h = 1$ mm. Determine the lengths and widths of all required microstrip sections, choosing always the shortest possible lengths.

Solution: For the quarter-wavelength transformer with a series section, it turns out that the shortest length corresponds to a voltage maximum. The impedance Z_1 and section length L_{max} are computed with the MATLAB function `qwt1`:

$$[Z_1, L_{\text{max}}] = \text{qwt1}(Z_L, Z_0, \text{'max'}) \Rightarrow Z_1 = 98.8809 \Omega, \quad L_{\text{max}} = 0.1849$$

The widths and lengths of the microstrip sections are designed with the help of the functions `mstripr` and `mstripa`. For the quarter-wavelength section Z_1 , the corresponding width-to-height ratio $u_1 = w_1/h$ is calculated from `mstripr` and then used in `mstripa` to get the effective permittivity, from which the wavelength and length of the segment can be calculated:

$$u_1 = \text{mstripr}(\epsilon_r, Z_1) = 0.9164, \quad w_1 = u_1 h = 0.9164 \text{ mm}$$

$$\epsilon_{\text{eff}} = \text{mstripa}(\epsilon_r, u_1) = 1.7659, \quad \lambda_1 = \frac{\lambda_0}{\sqrt{\epsilon_{\text{eff}}}} = 4.5151 \text{ cm}, \quad l_1 = \frac{\lambda_1}{4} = 1.1288 \text{ cm}$$

where the free-space wavelength is $\lambda_0 = 6$ cm. Similarly, we find for the series segment with impedance $Z_2 = Z_0$ and length $L_2 = L_{\text{max}}$:

$$u_2 = \text{mstripr}(\epsilon_r, Z_2) = 3.0829, \quad w_2 = u_2 h = 3.0829 \text{ mm}$$

$$\epsilon_{\text{eff}} = \text{mstripa}(\epsilon_r, u_2) = 1.8813, \quad \lambda_2 = \frac{\lambda_0}{\sqrt{\epsilon_{\text{eff}}}} = 4.3745 \text{ cm}, \quad l_2 = L_2 \lambda_2 = 0.8090 \text{ cm}$$

For the case of the $\lambda/8$ shunt stub, we find from `qwt2`:

$$[Z_1, Z_2] = \text{qwt2}(Z_L, Z_0) = [45.6435, -31.2500] \Omega$$

where the negative Z_2 means that we should use either a shorted $3\lambda/8$ stub or an opened $\lambda/8$ one. Choosing the latter and setting $Z_2 = 31.25 \Omega$, we can go on to calculate the microstrip widths and lengths:

$$\begin{aligned} u_1 &= \text{mstripr}(\epsilon_r, Z_1) = 3.5241, & w_1 &= u_1 h = 3.5241 \text{ mm} \\ \epsilon_{\text{eff}} &= \text{mstripa}(\epsilon_r, u_1) = 1.8965, & \lambda_1 &= \frac{\lambda_0}{\sqrt{\epsilon_{\text{eff}}}} = 4.3569 \text{ cm}, & l_1 &= \frac{\lambda_1}{4} = 1.0892 \text{ cm} \\ u_2 &= \text{mstripr}(\epsilon_r, Z_2) = 5.9067, & w_2 &= u_2 h = 5.9067 \text{ mm} \\ \epsilon_{\text{eff}} &= \text{mstripa}(\epsilon_r, u_2) = 1.9567, & \lambda_2 &= \frac{\lambda_0}{\sqrt{\epsilon_{\text{eff}}}} = 4.2894 \text{ cm}, & l_2 &= \frac{\lambda_2}{8} = 0.5362 \text{ cm} \end{aligned}$$

For the third matching method, we use a shunt stub of impedance $Z_2 = 30 \Omega$. It turns out that the short-circuited version has the shorter length. We find with the help of `qwt3`:

$$[Z_1, d] = \text{qwt3}(Z_L, Z_0, Z_2, 's') \Rightarrow Z_1 = 45.6435 \Omega, \quad d = 0.3718$$

The microstrip width and length of the quarter-wavelength section Z_1 are the same as in the previous case, because the two cases differ only in the way the load susceptance is canceled. The microstrip parameters of the shunt stub are:

$$\begin{aligned} u_2 &= \text{mstripr}(\epsilon_r, Z_2) = 6.2258, & w_2 &= u_2 h = 6.2258 \text{ mm} \\ \epsilon_{\text{eff}} &= \text{mstripa}(\epsilon_r, u_2) = 1.9628, & \lambda_2 &= \frac{\lambda_0}{\sqrt{\epsilon_{\text{eff}}}} = 4.2826 \text{ cm}, & l_2 &= d\lambda_2 = 1.5921 \text{ cm} \end{aligned}$$

Had we used a 50Ω shunt segment, its width and length would be $w_2 = 3.0829 \text{ mm}$ and $l_2 = 1.7983 \text{ cm}$. Fig. 12.6.2 depicts the microstrip matching circuits. \square

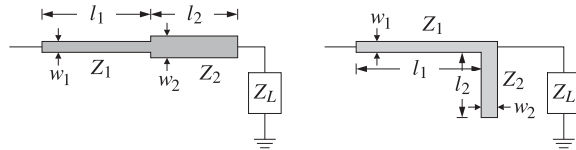

Fig. 12.6.2 Microstrip matching circuits.

12.7 Two-Section Series Impedance Transformer

One disadvantage of the quarter-wavelength transformer is that the required impedances of the line segments are not always easily realized. In certain applications, such as microwave integrated circuits, the segments are realized by microstrip lines whose impedances can be adjusted easily by changing the strip widths. In other applications, however, such as matching antennas to transmitters, we typically use standard 50- and 75-ohm coaxial cables and it is not possible to re-adjust their impedances.

The two-section series impedance transformer, shown in Fig. 12.7.1, addresses this problem [966,967]. It employs two line segments of *known* impedances Z_1 and Z_2 that have convenient values and adjusts their (electrical) lengths L_1 and L_2 to match a complex load Z_L to a main line of impedance Z_0 . Fig. 12.7.1 depicts this kind of transformer.

The design method is identical to that of designing two-layer antireflection coatings discussed in Sec. 6.2. Here, we modify that method slightly in order to handle complex load impedances. We assume that $Z_0, Z_1,$ and Z_2 are real and the load complex, $Z_L = R_L + jX_L$.

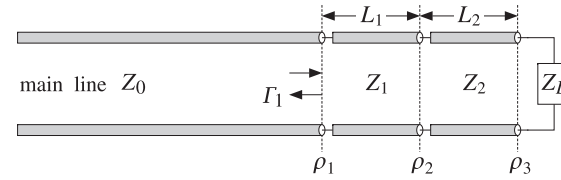

Fig. 12.7.1 Two-section series impedance transformer.

Defining the phase thicknesses of the two segments by $\delta_1 = 2\pi n_1 l_1 / \lambda_0 = 2\pi L_1$ and $\delta_2 = 2\pi n_2 l_2 / \lambda_0 = 2\pi L_2$, the reflection responses Γ_1 and Γ_2 at interfaces 1 and 2 are:

$$\Gamma_1 = \frac{\rho_1 + \Gamma_2 e^{-2j\delta_1}}{1 + \rho_1 \Gamma_2 e^{-2j\delta_1}}, \quad \Gamma_2 = \frac{\rho_2 + \rho_3 e^{-2j\delta_2}}{1 + \rho_2 \rho_3 e^{-2j\delta_2}}$$

where the elementary reflection coefficients are:

$$\rho_1 = \frac{Z_1 - Z_0}{Z_1 + Z_0}, \quad \rho_2 = \frac{Z_2 - Z_1}{Z_2 + Z_1}, \quad \rho_3 = \frac{Z_L - Z_2}{Z_L + Z_2}$$

The coefficients ρ_1, ρ_2 are real, but ρ_3 is complex, and we may represent it in polar form $\rho_3 = |\rho_3| e^{j\theta_3}$. The reflectionless matching condition is $\Gamma_1 = 0$ (at the operating free-space wavelength λ_0). This requires that $\rho_1 + \Gamma_2 e^{-2j\delta_1} = 0$, which implies:

$$e^{2j\delta_1} = -\frac{\Gamma_2}{\rho_1} \tag{12.7.1}$$

Because the left-hand side has unit magnitude, we must have the condition $|\Gamma_2| = |\rho_1|$, or, $|\Gamma_2|^2 = \rho_1^2$, which is written as:

$$\left| \frac{\rho_2 + |\rho_3| e^{j\theta_3} e^{-2j\delta_2}}{1 + \rho_2 |\rho_3| e^{j\theta_3} e^{-2j\delta_2}} \right|^2 = \frac{\rho_2^2 + |\rho_3|^2 + 2\rho_2 |\rho_3| \cos(2\delta_2 - \theta_3)}{1 + \rho_2^2 |\rho_3|^2 + 2\rho_2 |\rho_3| \cos(2\delta_2 - \theta_3)} = \rho_1^2$$

Using the identity $\cos(2\delta_2 - \theta_3) = 2 \cos^2(\delta_2 - \theta_3/2) - 1$, we find:

$$\begin{aligned} \cos^2\left(\delta_2 - \frac{\theta_3}{2}\right) &= \frac{\rho_1^2 (1 - \rho_2 |\rho_3|)^2 - (\rho_2 - |\rho_3|)^2}{4\rho_2 |\rho_3| (1 - \rho_1^2)} \\ \sin^2\left(\delta_2 - \frac{\theta_3}{2}\right) &= \frac{(\rho_2 + |\rho_3|)^2 - \rho_1^2 (1 + \rho_2 |\rho_3|)^2}{4\rho_2 |\rho_3| (1 - \rho_1^2)} \end{aligned} \tag{12.7.2}$$

Not every combination of ρ_1, ρ_2, ρ_3 will result into a solution for δ_2 because the left-hand sides must be positive and less than unity. If a solution for δ_2 exists, then δ_1 is determined from Eq. (12.7.1). Actually, there are two solutions for δ_2 corresponding to the \pm signs of the square root of Eq. (12.7.2), that is, we have:

$$\delta_2 = \frac{1}{2}\theta_3 + \text{acos} \left[\pm \left(\frac{\rho_1^2(1 - \rho_2|\rho_3|)^2 - (\rho_2 - |\rho_3|)^2}{4\rho_2|\rho_3|(1 - \rho_1^2)} \right)^{1/2} \right] \quad (12.7.3)$$

If the resulting value of δ_2 is negative, it may be shifted by π or 2π to make it positive, and then solve for the electrical length $L_2 = \delta_2/2\pi$. An alternative way of writing Eqs. (12.7.2) is in terms of the segment impedances (see also Problem 6.6):

$$\begin{aligned} \cos^2\left(\delta_2 - \frac{\theta_3}{2}\right) &= \frac{(Z_2^2 - Z_3Z_0)(Z_3Z_1^2 - Z_0Z_2^2)}{Z_0(Z_2^2 - Z_3^2)(Z_1^2 - Z_2^2)} \\ \sin^2\left(\delta_2 - \frac{\theta_3}{2}\right) &= \frac{Z_2^2(Z_0 - Z_3)(Z_1^2 - Z_0Z_3)}{Z_0(Z_2^2 - Z_3^2)(Z_1^2 - Z_2^2)} \end{aligned} \quad (12.7.4)$$

where Z_3 is an equivalent "resistive" termination defined in terms of the load impedance through the relationship:

$$\frac{Z_3 - Z_2}{Z_3 + Z_2} = |\rho_3| = \left| \frac{Z_L - Z_2}{Z_L + Z_2} \right| \quad (12.7.5)$$

Clearly, if Z_L is real and greater than Z_2 , then $Z_3 = Z_L$, whereas if it is less than Z_2 , then, $Z_3 = Z_2^2/Z_L$. Eq. (12.7.4) shows more clearly the conditions for existence of solutions. In the special case when section-2 is a section of the main line, so that $Z_2 = Z_0$, then (12.7.4) simplifies to:

$$\begin{aligned} \cos^2\left(\delta_2 - \frac{\theta_3}{2}\right) &= \frac{Z_3Z_1^2 - Z_0^3}{(Z_3 + Z_0)(Z_1^2 - Z_0^2)} \\ \sin^2\left(\delta_2 - \frac{\theta_3}{2}\right) &= \frac{Z_0(Z_1^2 - Z_0Z_3)}{(Z_3 + Z_0)(Z_1^2 - Z_0^2)} \end{aligned} \quad (12.7.6)$$

It is easily verified from these expressions that the condition for the existence of solutions is that the equivalent load impedance Z_3 lie within the intervals:

$$\begin{aligned} \frac{Z_0^3}{Z_1^2} \leq Z_3 \leq \frac{Z_1^2}{Z_0}, \quad \text{if } Z_1 > Z_0 \\ \frac{Z_1^2}{Z_0} \leq Z_3 \leq \frac{Z_0^3}{Z_1^2}, \quad \text{if } Z_1 < Z_0 \end{aligned} \quad (12.7.7)$$

They may be combined into the single condition:

$$\boxed{\frac{Z_0}{S^2} \leq Z_3 \leq Z_0 S^2}, \quad S = \frac{\max(Z_1, Z_0)}{\min(Z_1, Z_0)} = \text{swr}(Z_1, Z_0) \quad (12.7.8)$$

Example 12.7.1: Matching range with 50- and 75-ohm lines. If $Z_0 = 50$ and $Z_1 = 75$ ohm, then the following loads can be matched by this method:

$$\frac{50^3}{75^2} \leq Z_3 \leq \frac{75^2}{50} \Rightarrow 22.22 \leq Z_3 \leq 112.50 \Omega$$

And, if $Z_0 = 75$ and $Z_1 = 50$, the following loads can be matched:

$$\frac{50^2}{75} \leq Z_3 \leq \frac{75^3}{50^2} \Rightarrow 33.33 \leq Z_3 \leq 168.75 \Omega$$

In general, the farther Z_1 is from Z_0 , the wider the range of loads that can be matched. For example, with $Z_0 = 75$ and $Z_1 = 300$ ohm, all loads in the range from 4.5 to 1200 ohm can be matched. \square

The MATLAB function `twosect` implements the above design procedure. Its inputs are the impedances Z_0, Z_1, Z_2 , and the complex Z_L , and its outputs are the two solutions for L_1 and L_2 , if they exist. Its usage is as follows, where L_{12} is a 2×2 matrix whose rows are the two possible sets of values of L_1, L_2 :

```
L12 = twosect(Z0,Z1,Z2,ZL); % two-section series impedance transformer
```

The essential code in this function is as follows:

```
r1 = (Z1-Z0)/(Z1+Z0);
r2 = (Z2-Z1)/(Z2+Z1);
r3 = abs((ZL-Z2)/(ZL+Z2));
th3 = angle((ZL-Z2)/(ZL+Z2));

s = ((r2+r3)^2 - r1^2*(1+r2*r3)^2) / (4*r2*r3*(1-r1^2));
if (s<0)|(s>1), fprintf('no solution exists'); return; end

de2 = th3/2 + asin(sqrt(s)) * [1;-1]; % construct two solutions

G2 = (r2 + r3*exp(j*th3-2*j*de2)) ./ (1 + r2*r3*exp(j*th3-2*j*de2));

de1 = angle(-G2/r1)/2;

L1 = de1/2/pi; L2 = de2/2/pi;

L12 = mod([L1,L2], 0.5); % reduce modulo lambda/2
```

Example 12.7.2: Matching an antenna with coaxial cables. A 29-MHz amateur radio antenna with input impedance of 38 ohm is to be fed by a 50-ohm RG-58/U cable. Design a two-section series impedance transformer consisting of a length of RG-59/U 75-ohm cable inserted into the main line at an appropriate distance from the antenna [967]. The velocity factor of both cables is 0.79.

Solution: Here, we have $Z_0 = 50$, $Z_1 = 75$, $Z_2 = Z_0$, and $Z_L = 38$ ohm. The call to the function `twosect` results in the MATLAB output for the electrical lengths of the segments:

$$L_{12} = \begin{bmatrix} 0.0536 & 0.3462 \\ 0.4464 & 0.1538 \end{bmatrix} \Rightarrow \begin{matrix} L_1 = 0.0536, & L_2 = 0.3462 \\ L_1 = 0.4464, & L_2 = 0.1538 \end{matrix}$$

Using the given velocity factor, the operating wavelength is $\lambda = 0.79\lambda_0 = 0.79c_0/f_0 = 8.1724$ m, where $f_0 = 29$ MHz. Therefore, the actual physical lengths for the segments are, for the first possible solution:

$$l_1 = 0.0536\lambda = 0.4379 \text{ m} = 1.4367 \text{ ft}, \quad l_2 = 0.3462\lambda = 2.8290 \text{ m} = 9.2813 \text{ ft}$$

and for the second solution:

$$l_1 = 0.4464\lambda = 3.6483 \text{ m} = 11.9695 \text{ ft}, \quad l_2 = 0.1538\lambda = 1.2573 \text{ m} = 4.1248 \text{ ft}$$

Fig. 12.7.2 depicts the corresponding reflection responses at interface-1, $|\Gamma_1(f)|$, as a function of frequency. The standing wave ratio on the main line is also shown, that is, the quantity $S_1(f) = (1 + |\Gamma_1(f)|) / (1 - |\Gamma_1(f)|)$.

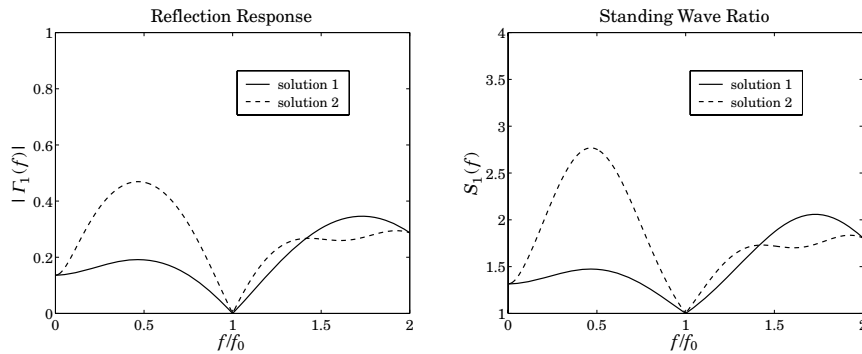

Fig. 12.7.2 Reflection response of two-section series transformer.

The reflection response was computed with the help of `multiline`. The typical MATLAB code for this example was:

```
Z0 = 50; Z1 = 75; ZL = 38;
c0 = 3e8; f0 = 29e6; vf = 0.79;
la0 = c0/f0; la = la0*vf;

L12 = twosect(Z0,Z1,Z0,ZL);

f = linspace(0,2,401); % in units of f₀

G1 = abs(multiline([Z0,Z1,Z0],L12(1,:),ZL,f)); % reflection response 1
G2 = abs(multiline([Z0,Z1,Z0],L12(2,:),ZL,f)); % reflection response 2

S1=(1+G1)./(1-G1); S2=(1+G2)./(1-G2); % SWRs
```

We note that the two solutions have unequal bandwidths. □

Example 12.7.3: Matching a complex load. Design a 75-ohm series section to be inserted into a 300-ohm line that feeds the load $600 + 900j$ ohm [967].

Solution: The MATLAB call

```
L12 = twosect(300, 75, 300, 600+900j);
```

produces the solutions: $L_1 = [0.3983, 0.1017]$ and $L_2 = [0.2420, 0.3318]$. □

One-section series impedance transformer

We mention briefly also the case of the one-section series impedance transformer, shown in Fig. 12.7.3. This is one of the earliest impedance transformers [961–965]. It has limited use in that not all complex loads can be matched, although its applicability can be extended somewhat [965].

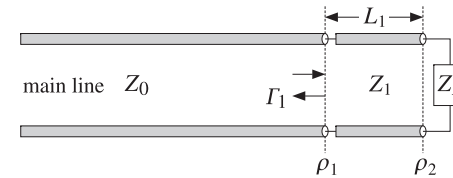

Fig. 12.7.3 One-section series impedance transformer.

Both the section impedance Z_1 and length L_1 are treated as unknowns to be fixed by requiring the matching condition $\Gamma_1 = 0$ at the operating frequency. It is left as an exercise (see Problem 12.9) to show that the solution is given by:

$$Z_1 = \sqrt{Z_0 R_L - \frac{Z_0 X_L^2}{Z_0 - R_L}}, \quad L_1 = \frac{1}{2\pi} \operatorname{atan} \left[\frac{Z_1 (Z_0 - R_L)}{Z_0 X_L} \right] \quad (12.7.9)$$

provided that either of the following conditions is satisfied:

$$Z_0 < R_L \quad \text{or} \quad Z_0 > R_L + \frac{X_L^2}{R_L} \quad (12.7.10)$$

In particular, there is always a solution if Z_L is real. The MATLAB function `onesect` implements this method. It has usage:

```
[Z1,L1] = onesect(ZL,Z0); % one-section series impedance transformer
```

where L_1 is the normalized length $L_1 = l_1/\lambda_1$, with l_1 and λ_1 the physical length and wavelength of the Z_1 section. The routine outputs the smallest positive L_1 .

12.8 Single Stub Matching

Stub tuners are widely used to match any complex load[†] to a main line. They consist of shorted or opened segments of the line, connected in parallel or in series with the line at a appropriate distances from the load.

[†]The resistive part of the load must be non-zero. Purely reactive loads cannot be matched to a real line impedance by this method nor by any of the other methods discussed in this chapter. This is so because the transformation of a reactive load through the matching circuits remains reactive.

In coaxial cable or two-wire line applications, the stubs are obtained by cutting appropriate lengths of the main line. Shorted stubs are usually preferred because opened stubs may radiate from their opened ends. However, in microwave integrated circuits employing microstrip lines, radiation is not as a major concern because of their smaller size, and either opened or shorted stubs may be used.

The single stub tuner is perhaps the most widely used matching circuit and can match any load. However, it is sometimes inconvenient to connect to the main line if different loads are to be matched. In such cases, double stubs may be used, but they cannot match all loads. Triple stubs can match any load. A single stub tuner is shown in Figs. 12.8.1 and 12.8.2, connected in parallel and in series.

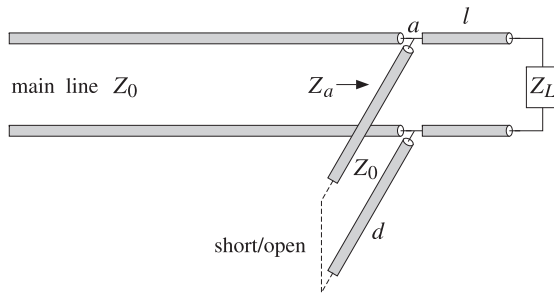

Fig. 12.8.1 Parallel connection of single stub tuner.

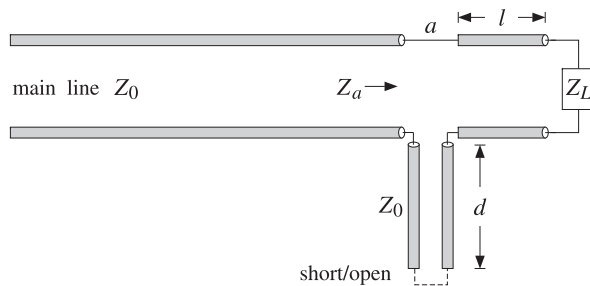

Fig. 12.8.2 Series connection of single stub tuner.

In the parallel case, the admittance $Y_a = 1/Z_a$ at the stub location a is the sum of the admittances of the length- d stub and the wave admittance at distance l from the load, that is,

$$Y_a = Y_l + Y_{\text{stub}} = Y_0 \frac{1 - \Gamma_l}{1 + \Gamma_l} + Y_{\text{stub}}$$

where $\Gamma_l = \Gamma_L e^{-2j\beta l}$. The admittance of a short-circuited stub is $Y_{\text{stub}} = -jY_0 \cot \beta d$, and of an open-circuited one, $Y_{\text{stub}} = jY_0 \tan \beta d$. The matching condition is that $Y_a = Y_0$. Assuming a short-circuited stub, we have:

$$Y_0 \frac{1 - \Gamma_l}{1 + \Gamma_l} - jY_0 \cot \beta d = Y_0 \Rightarrow \frac{1 - \Gamma_l}{1 + \Gamma_l} - j \cot \beta d = 1$$

which can be rearranged into the form:

$$2j \tan \beta d = 1 + \frac{1}{\Gamma_l} \tag{12.8.1}$$

Inserting $\Gamma_l = \Gamma_L e^{-2j\beta l} = |\Gamma_L| e^{j\theta_L - 2j\beta l}$, where $\Gamma_L = |\Gamma_L| e^{j\theta_L}$ is the polar form of the load reflection coefficient, we may write (12.8.1) as:

$$2j \tan \beta d = 1 + \frac{e^{j(2\beta l - \theta_L)}}{|\Gamma_L|} \tag{12.8.2}$$

Equating real and imaginary parts, we obtain the equivalent conditions:

$$\cos(2\beta l - \theta_L) = -|\Gamma_L|, \quad \tan \beta d = \frac{\sin(2\beta l - \theta_L)}{2|\Gamma_L|} = -\frac{1}{2} \tan(2\beta l - \theta_L) \tag{12.8.3}$$

The first of (12.8.3) may be solved resulting in two solutions for l ; then, the second equation may be solved for the corresponding values of d :

$$\beta l = \frac{1}{2} \theta_L \pm \frac{1}{2} \arccos(-|\Gamma_L|), \quad \beta d = \operatorname{atan}\left(-\frac{1}{2} \tan(2\beta l - \theta_L)\right) \tag{12.8.4}$$

The resulting values of l, d must be made positive by reducing them modulo $\lambda/2$. In the case of an open-circuited shunt stub, the first equation in (12.8.3) remains the same, and in the second we must replace $\tan \beta d$ by $-\cot \beta d$. In the series connection of a shorted stub, the impedances are additive at point a , resulting in the condition:

$$Z_a = Z_l + Z_{\text{stub}} = Z_0 \frac{1 + \Gamma_l}{1 - \Gamma_l} + jZ_0 \tan \beta d = Z_0 \Rightarrow \frac{1 + \Gamma_l}{1 - \Gamma_l} + j \tan \beta d = 1$$

This may be solved in a similar fashion as Eq. (12.8.1). We summarize below the solutions in the four cases of parallel or series connections with shorted or opened stubs:

$$\begin{aligned} \beta l &= \frac{1}{2} [\theta_L \pm \arccos(-|\Gamma_L|)], & \beta d &= \operatorname{atan}\left(-\frac{1}{2} \tan(2\beta l - \theta_L)\right), & \text{parallel/shorted} \\ \beta l &= \frac{1}{2} [\theta_L \pm \arccos(-|\Gamma_L|)], & \beta d &= \operatorname{acot}\left(\frac{1}{2} \tan(2\beta l - \theta_L)\right), & \text{parallel/opened} \\ \beta l &= \frac{1}{2} [\theta_L \pm \arccos(|\Gamma_L|)], & \beta d &= \operatorname{acot}\left(\frac{1}{2} \tan(2\beta l - \theta_L)\right), & \text{series/shorted} \\ \beta l &= \frac{1}{2} [\theta_L \pm \arccos(|\Gamma_L|)], & \beta d &= \operatorname{atan}\left(-\frac{1}{2} \tan(2\beta l - \theta_L)\right), & \text{series/opened} \end{aligned}$$

The MATLAB function `stub1` implements these equations. Its input is the normalized load impedance, $z_L = Z_L/Z_0$, and the desired type of stub. Its outputs are the dual solutions for the lengths d, l , arranged in the rows of a 2x2 matrix `d1`. Its usage is as follows:

```
d1 = stub1(zL,type); % single stub tuner
```

The parameter `type` takes on the string values 'ps', 'po', 'ss', 'so', for parallel/short, parallel/open, series/short, series/open stubs.

Example 12.8.1: The load impedance $Z_L = 10 - 5j$ ohm is to be matched to a 50-ohm line. The normalized load is $z_L = Z_L/Z_0 = 0.2 - 0.1j$. The MATLAB calls, `d1=stub1(zL,type)`, result into the following solutions for the cases of parallel/short, parallel/open, series/short, series/open stubs:

$$\begin{bmatrix} 0.0806 & 0.4499 \\ 0.4194 & 0.0831 \end{bmatrix}, \begin{bmatrix} 0.3306 & 0.4499 \\ 0.1694 & 0.0831 \end{bmatrix}, \begin{bmatrix} 0.1694 & 0.3331 \\ 0.3306 & 0.1999 \end{bmatrix}, \begin{bmatrix} 0.4194 & 0.3331 \\ 0.0806 & 0.1999 \end{bmatrix}$$

Each row represents a possible solution for the electrical lengths d/λ and l/λ . We illustrate below the solution details for the parallel/short case.

Given the load impedance $z_L = 0.2 - 0.1j$, we calculate the reflection coefficient and put it in polar form:

$$\Gamma_L = \frac{z_L - 1}{z_L + 1} = -0.6552 - 0.1379j \Rightarrow |\Gamma_L| = 0.6695, \quad \theta_L = -2.9341 \text{ rad}$$

Then, the solution of Eq. (12.8.4) is:

$$\beta l = \frac{1}{2} [\theta_L \pm \text{acos}(-|\Gamma_L|)] = \frac{1}{2} [-2.9341 \pm \text{acos}(-0.6695)] = \frac{1}{2} [-2.9341 \pm 2.3044]$$

which gives the two solutions:

$$\beta l = \frac{2\pi l}{\lambda} = \begin{bmatrix} -0.3149 \text{ rad} \\ -2.6192 \text{ rad} \end{bmatrix} \Rightarrow l = \frac{\lambda}{2\pi} \begin{bmatrix} -0.3149 \\ -2.6192 \end{bmatrix} = \begin{bmatrix} -0.0501\lambda \\ -0.4169\lambda \end{bmatrix}$$

These may be brought into the interval $[0, \lambda/2]$ by adding enough multiples of $\lambda/2$. The built-in MATLAB function `mod` does just that. In this case, a single multiple of $\lambda/2$ suffices, resulting in:

$$l = \begin{bmatrix} -0.0501\lambda + 0.5\lambda \\ -0.4169\lambda + 0.5\lambda \end{bmatrix} = \begin{bmatrix} 0.4499\lambda \\ 0.0831\lambda \end{bmatrix} \Rightarrow \beta l = \begin{bmatrix} 2.8267 \text{ rad} \\ 0.5224 \text{ rad} \end{bmatrix}$$

With these values of βl , we calculate the stub length d :

$$\beta d = \text{atan}\left(-\frac{1}{2} \tan(2\beta l - \theta_L)\right) = \begin{bmatrix} 0.5064 \text{ rad} \\ -0.5064 \text{ rad} \end{bmatrix} \Rightarrow d = \begin{bmatrix} 0.0806\lambda \\ -0.0806\lambda \end{bmatrix}$$

Shifting the second d by $\lambda/2$, we finally find:

$$d = \begin{bmatrix} 0.0806\lambda \\ -0.0806\lambda + 0.5\lambda \end{bmatrix} = \begin{bmatrix} 0.0806\lambda \\ 0.4194\lambda \end{bmatrix}, \quad \beta d = \begin{bmatrix} 0.5064 \text{ rad} \\ 2.6351 \text{ rad} \end{bmatrix}$$

Next, we verify the matching condition. The load admittance is $y_L = 1/z_L = 4 + 2j$. Propagating it to the left of the load by a distance l , we find for the two values of l and for the corresponding values of d :

$$y_l = \frac{y_L + j \tan \beta l}{1 + jy_L \tan \beta l} = \begin{bmatrix} 1.0000 + 1.8028j \\ 1.0000 - 1.8028j \end{bmatrix}, \quad y_{\text{stub}} = -j \cot \beta d = \begin{bmatrix} -1.8028j \\ 1.8028j \end{bmatrix}$$

For both solutions, the susceptance of y_l is canceled by the susceptance of the stub, resulting in the matched total normalized admittance $y_a = y_l + y_{\text{stub}} = 1$. \square

Example 12.8.2: Match the antenna and feed line of Example 12.7.2 using a single shorted or opened stub. Plot the corresponding matched reflection responses.

Solution: The normalized load impedance is $z_L = 38/50 = 0.76$. The MATLAB function `stub1` yields the following solutions for the lengths d, l , in the cases of parallel/short, parallel/open, series/short, series/open stubs:

$$\begin{bmatrix} 0.2072 & 0.3859 \\ 0.2928 & 0.1141 \end{bmatrix}, \begin{bmatrix} 0.4572 & 0.3859 \\ 0.0428 & 0.1141 \end{bmatrix}, \begin{bmatrix} 0.0428 & 0.3641 \\ 0.4572 & 0.1359 \end{bmatrix}, \begin{bmatrix} 0.2928 & 0.3641 \\ 0.2072 & 0.1359 \end{bmatrix},$$

These numbers must be multiplied by λ_0 , the free-space wavelength corresponding to the operating frequency of $f_0 = 29$ MHz. The resulting reflection responses $|\Gamma_a(f)|$ at the connection point a of the stub, corresponding to all the pairs of d, l are shown in Fig. 12.8.3. For example, in the parallel/short case, Γ_a is calculated by

$$\Gamma_a = \frac{1 - y_a}{1 + y_a}, \quad y_a = \frac{1 - \Gamma_L e^{-2j\beta l}}{1 + \Gamma_L e^{-2j\beta l}} - j \cot \beta d, \quad \beta l = 2\pi \frac{f}{f_0} \frac{l}{\lambda_0}, \quad \beta d = 2\pi \frac{f}{f_0} \frac{d}{\lambda_0}$$

We note that different solutions can have very different bandwidths. \square

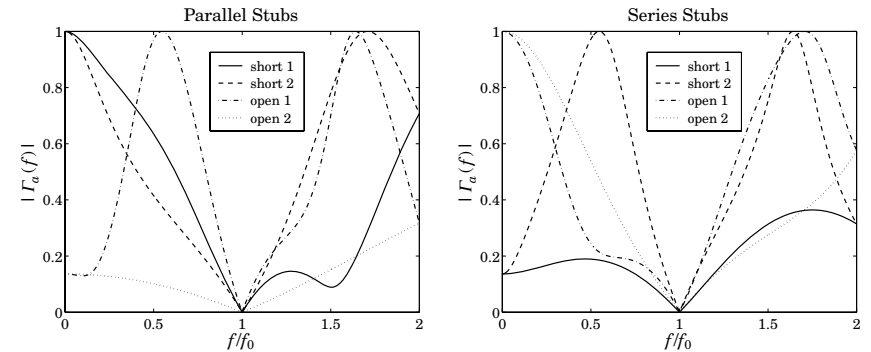

Fig. 12.8.3 Reflection response of single stub matching solutions.

12.9 Balanced Stubs

In microstrip realizations of single-stub tuners, balanced stubs are often used to reduce the transitions between the series and shunt segments. Fig. 12.9.1 depicts two identical balanced stubs connected at opposite sides of the main line.

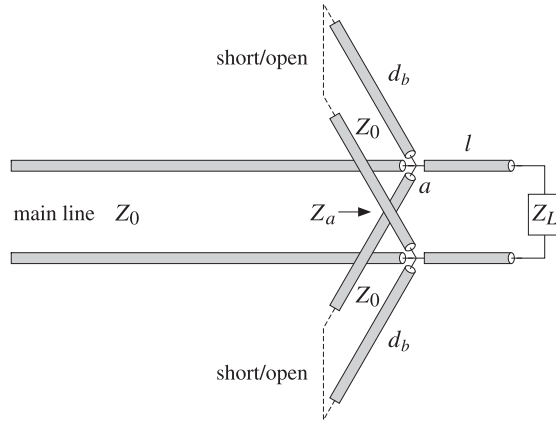

Fig. 12.9.1 Balanced stubs.

Because of the parallel connection, the total admittance of the stubs will be double that of each leg, that is, $Y_{\text{bal}} = 2Y_{\text{stub}}$. A single unbalanced stub of length d can be converted into an equivalent balanced stub of length d_b by requiring that the two configurations provide the same admittance. Depending on whether shorted or opened stubs are used, we obtain the relationships between d_b and d :

$$\begin{aligned}
 2 \cot \beta d_b &= \cot \beta d \quad \Rightarrow \quad d_b = \frac{\lambda}{2\pi} \operatorname{acot}(0.5 \cot \beta d) \quad (\text{shorted}) \\
 2 \tan \beta d_b &= \tan \beta d \quad \Rightarrow \quad d_b = \frac{\lambda}{2\pi} \operatorname{atan}(0.5 \tan \beta d) \quad (\text{opened})
 \end{aligned}
 \tag{12.9.1}$$

The microstrip realization of such a balanced stub is shown in Fig. 12.9.2. The figure also shows the use of balanced stubs for quarter-wavelength transformers with a shunt stub as discussed in Sec. 12.6.

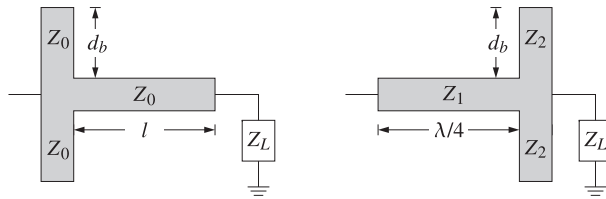

Fig. 12.9.2 Balanced microstrip single-stub and quarter-wavelength transformers.

If the shunt stub has length $\lambda/8$ or $3\lambda/8$, then the impedance Z_2 of each leg must be double that of the single-stub case. On the other hand, if the impedance Z_2 is fixed, then the stub length d_b of each leg may be calculated by Eq. (12.9.1).

12.10 Double and Triple Stub Matching

Because the stub distance l from the load depends on the load impedance to be matched, the single-stub tuner is inconvenient if several different load impedances are to be matched, each requiring a different value for l .

The double-stub tuner, shown in Fig. 12.10.1, provides an alternative matching method in which two stubs are used, one at the load and another at a fixed distance l from the load, where typically, $l = \lambda/8$. Only the stub lengths d_1, d_2 need to be adjusted to match the load impedance.

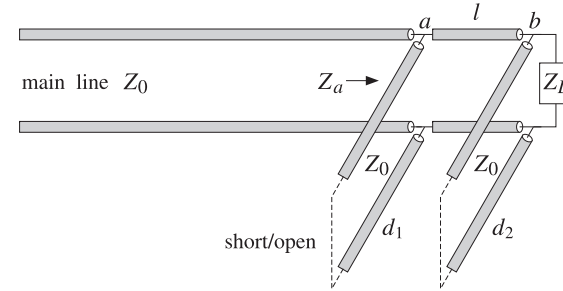

Fig. 12.10.1 Double stub tuner.

The two stubs are connected in parallel to the main line and can be short- or open-circuited. We discuss the matching conditions for the case of shorted stubs.

Let $Y_L = 1/Z_L = G_L + jB_L$ be the load admittance, and define its normalized version $y_L = Y_L/Y_0 = g_L + jb_L$, where g_L, b_L are the normalized load conductance and susceptance. At the connection points a, b , the total admittance is the sum of the wave admittance of the line and the stub admittance:

$$\begin{aligned}
 y_a &= y_l + y_{\text{stub},1} = \frac{y_b + j \tan \beta l}{1 + jy_b \tan \beta l} - j \cot \beta d_1 \\
 y_b &= y_L + y_{\text{stub},2} = g_L + j(b_L - \cot \beta d_2)
 \end{aligned}$$

The matching condition is $y_a = 1$, which gives rise to two equations that can be solved for the unknown lengths d_1, d_2 . It is left as an exercise (see Problem 12.10) to show that the solutions are given by:

$$\cot \beta d_2 = b_L - b, \quad \cot \beta d_1 = \frac{1 - b \tan \beta l - g_L}{g_L \tan \beta l}
 \tag{12.10.1}$$

where

$$b = \cot \beta l \pm \sqrt{g_L (g_{\text{max}} - g_L)}, \quad g_{\text{max}} = 1 + \cot^2 \beta l = \frac{1}{\sin^2 \beta l}
 \tag{12.10.2}$$

Evidently, the condition for the existence of a real-valued b is that the load conductance g_L be less than g_{max} , that is, $g_L \leq g_{\text{max}}$. If this condition is not satisfied, the

load cannot be matched with any stub lengths d_1, d_2 . Stub separations near $\lambda/2$, or near zero, result in $g_{\max} = \infty$, but are not recommended because they have very narrow bandwidths [870].

Assuming $l \leq \lambda/4$, the condition $g_L \leq g_{\max}$ can be turned around into a condition for the maximum length l that will admit a matching solution for the given load:

$$l \leq l_{\max} = \frac{\lambda}{2\pi} \operatorname{asin}\left(\frac{1}{\sqrt{g_L}}\right) \quad (\text{maximum stub separation}) \quad (12.10.3)$$

If the existence condition is satisfied, then Eq. (12.10.2) results in two solutions for b and, hence for, d_1, d_2 . The lengths d_1, d_2 must be reduced modulo $\lambda/2$ to bring them within the minimum interval $[0, \lambda/2]$.

If any of the stubs are open-circuited, the corresponding quantity $\cot \beta d_i$ must be replaced by $-\tan \beta d_i = \cot(\beta d_i - \pi/2)$.

The MATLAB function `stub2` implements the above design procedure. Its inputs are the normalized load impedance $z_L = Z_L/Z_0$, the stub separation l , and the stub types, and its outputs are the two possible solutions for the d_1, d_2 . Its usage is as follows:

```
d12 = stub2(zL, l, type);           % double stub tuner
d12 = stub2(zL, l);                % equivalent to type='ss'
d12 = stub2(zL);                   % equivalent to l = 1/8 and type='ss'
```

The parameter `type` takes on the strings values: 'ss', 'so', 'os', 'oo', for short/short, short/open, open/short, open/open stubs. If the existence condition fails, the function outputs the maximum separation l_{\max} that will admit a solution.

A triple stub tuner, shown in Fig. 12.10.2, can match any load. The distances l_1, l_2 between the stubs are fixed and only the stub lengths d_1, d_2, d_3 are adjustable.

The first two stubs (from the left) can be thought of as a double-stub tuner. The purpose of the third stub at the load is to ensure that the wave impedance seen by the double-stub tuner satisfies the existence condition $g_L \leq g_{\max}$.

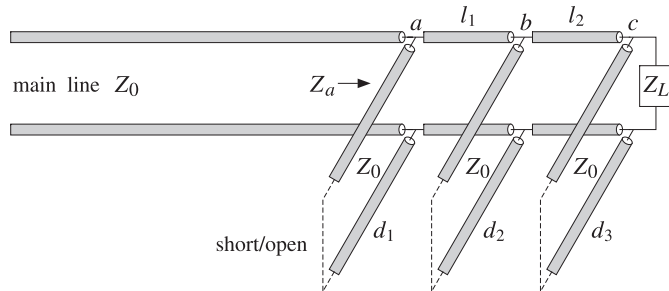

Fig. 12.10.2 Triple stub tuner.

The total admittance at the load point c , and its propagated version by distance l_2 to point b are given by:

$$y_l = \frac{y_c + j \tan \beta l_2}{1 + j y_c \tan \beta l_2}, \quad y_c = y_L + y_{\text{stub},3} = g_L + j b_L - j \cot \beta d_3 = g_L + j b \quad (12.10.4)$$

where $b = b_L - \cot \beta d_3$. The corresponding conductance is:

$$g_l = \operatorname{Re}(y_l) = \frac{g_L(1 + \tan^2 \beta l_2)}{(b \tan \beta l_2 - 1)^2 + g_L^2 \tan^2 \beta l_2} \quad (12.10.5)$$

The first two stubs see the effective load y_l . The double-stub problem will have a solution provided $g_l \leq g_{\max,1} = 1/\sin^2 \beta l_1$. The length d_3 of the third stub is adjusted to ensure this condition. To parametrize the possible solutions, we introduce a “smallness” parameter $e < 1$ such that $g_l = e g_{\max,1}$. This gives the existence condition:

$$g_l = \frac{g_L(1 + \tan^2 \beta l_2)}{(b \tan \beta l_2 - 1)^2 + g_L^2 \tan^2 \beta l_2} = e g_{\max,1}$$

which can be rewritten in the form:

$$(b - \cot \beta l_2)^2 = g_L(g_{\max,2} - e g_{\max,1} g_L) = g_L^2 g_{\max,1}(e_{\max} - e)$$

where we defined $g_{\max,2} = 1 + \cot^2 \beta l_2 = 1/\sin^2 \beta l_2$ and $e_{\max} = g_{\max,2}/(g_L g_{\max,1})$. If $e_{\max} < 1$, we may replace e by the minimum of the chosen e and e_{\max} . But if $e_{\max} > 1$, we just use the chosen e . In other words, we replace the above condition with:

$$(b - \cot \beta l_2)^2 = g_L^2 g_{\max,1}(e_{\max} - e_{\min}), \quad e_{\min} = \min(e, e_{\max}) \quad (12.10.6)$$

It corresponds to setting $g_l = e_{\min} g_{\max,1}$. Solving Eq. (12.10.6) for $\cot \beta d_3$ gives the two solutions:

$$\cot \beta d_3 = b_L - b, \quad b = \cot \beta l_2 \pm g_L \sqrt{g_{\max,1}(e_{\max} - e_{\min})} \quad (12.10.7)$$

For each of the two values of d_3 , there will be a feasible solution to the double-stub problem, which will generate two possible solutions for d_1, d_2 . Thus, there will be a total of four triples d_1, d_2, d_3 that will satisfy the matching conditions. Each stub can be shorted or opened, resulting into eight possible choices for the stub triples.

The MATLAB function `stub3` implements the above design procedure. It generates a 4×3 matrix of solutions and its usage is:

```
d123 = stub3(zL, l1, l2, type, e); % triple stub tuner
d123 = stub3(zL, l1, l2, type);   % equivalent to e = 0.9
d123 = stub3(zL, l1, l2);        % equivalent to e = 0.9, type='sss'
d123 = stub3(zL);                 % equivalent to e = 0.9, type='sss', l1 = l2 = 1/8
```

where `type` takes on one of the eight possible string values, defining whether the first, second, or third stubs are short- or open-circuited: 'sss', 'sso', 'sos', 'soo', 'oss', 'oso', 'oos', 'ooo'.

12.11 L-Section Lumped Reactive Matching Networks

Impedance matching by stubs or series transmission line segments is appropriate at higher frequencies, such as microwave frequencies. At lower RF frequencies, lumped-parameter circuit elements may be used to construct a matching network. Here, we discuss L-section, Π -section, and T-section matching networks.

The *L*-section matching network shown in Fig. 12.11.1 uses only reactive elements (inductors or capacitors) to conjugately match any load impedance Z_L to any generator impedance Z_G . The use of reactive elements minimizes power losses in the matching network.

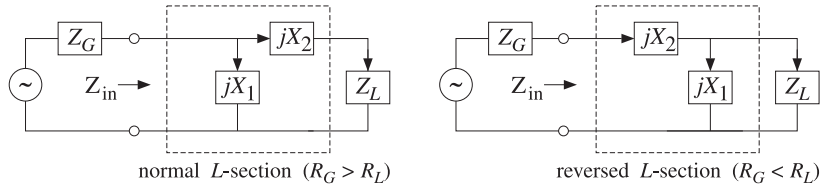

Fig. 12.11.1 *L*-section reactive conjugate matching network.

L-section networks are used to match the input and output impedances of amplifier circuits [1006–1014] and also to match transmitters to feed lines [44,45,968–975].

An arbitrary load impedance may be matched by a normal *L*-section, or if that is not possible, by a reversed *L*-section. Sometimes both normal and reversed types are possible. We derive below the conditions for the existence of a matching solution of a particular type.

The inputs to the design procedure are the complex load and generator impedances $Z_L = R_L + jX_L$ and $Z_G = R_G + jX_G$. The outputs are the reactances X_1, X_2 . For either type, the matching network transforms the load impedance Z_L into the complex conjugate of the generator impedance, that is,

$$Z_{in} = Z_G^* \quad (\text{conjugate match}) \quad (12.11.1)$$

where Z_{in} is the input impedance looking into the *L*-section:

$$\begin{aligned} Z_{in} &= \frac{Z_1(Z_2 + Z_L)}{Z_1 + Z_2 + Z_L} \quad (\text{normal}) \\ Z_{in} &= Z_2 + \frac{Z_1 Z_L}{Z_1 + Z_L} \quad (\text{reversed}) \end{aligned} \quad (12.11.2)$$

with $Z_1 = jX_1$ and $Z_2 = jX_2$. Inserting Eqs. (12.11.2) into the condition (12.11.1) and equating the real and imaginary parts of the two sides, we obtain a system of equations for X_1, X_2 with solutions for the two types:

$$\begin{aligned} \left[\begin{aligned} X_1 &= \frac{X_G \pm R_G Q}{\frac{R_G}{R_L} - 1} \\ X_2 &= -(X_L \pm R_L Q) \\ Q &= \sqrt{\frac{R_G}{R_L} - 1 + \frac{X_G^2}{R_G R_L}} \end{aligned} \right] \quad (\text{normal}), \quad \left[\begin{aligned} X_1 &= \frac{X_L \pm R_L Q}{\frac{R_L}{R_G} - 1} \\ X_2 &= -(X_G \pm R_G Q) \\ Q &= \sqrt{\frac{R_L}{R_G} - 1 + \frac{X_L^2}{R_G R_L}} \end{aligned} \right] \quad (\text{reversed}) \end{aligned} \quad (12.11.3)$$

If the load and generator impedances are both resistive, so that $X_L = 0$ and $X_G = 0$, the above solutions take the particularly simple forms:

$$\left[\begin{aligned} X_1 &= \pm \frac{R_G}{Q} \\ X_2 &= \mp R_L Q \\ Q &= \sqrt{\frac{R_G}{R_L} - 1} \end{aligned} \right] \quad (\text{normal}), \quad \left[\begin{aligned} X_1 &= \pm \frac{R_L}{Q} \\ X_2 &= \mp R_G Q \\ Q &= \sqrt{\frac{R_L}{R_G} - 1} \end{aligned} \right] \quad (\text{reversed}) \quad (12.11.4)$$

We note that the reversed solution is obtained from the normal one by exchanging Z_L with Z_G . Both solution types assume that $R_G \neq R_L$. If $R_G = R_L$, then for either type, we have the solution:

$$X_1 = \infty, \quad X_2 = -(X_L + X_G) \quad (12.11.5)$$

Thus, X_1 is open-circuited and X_2 is such that $X_2 + X_L = -X_G$. The Q quantities play the role of series impedance Q -factors. Indeed, the X_2 equations in all cases imply that Q is equal to the ratio of the total series reactance by the corresponding series resistance, that is, $(X_2 + X_L)/R_L$ or $(X_2 + X_G)/R_G$.

The conditions for real-valued solutions for X_1, X_2 are that the Q factors in (12.11.3) and (12.11.4) be real-valued or that the quantities under their square roots be non-negative. When $R_L \neq R_G$, it is straightforward to verify that this happens in the following four mutually exclusive cases:

existence conditions	<i>L</i> -section types
$R_G > R_L, \quad X_L \geq \sqrt{R_L(R_G - R_L)}$	normal and reversed
$R_G > R_L, \quad X_L < \sqrt{R_L(R_G - R_L)}$	normal only
$R_G < R_L, \quad X_G \geq \sqrt{R_G(R_L - R_G)}$	normal and reversed
$R_G < R_L, \quad X_G < \sqrt{R_G(R_L - R_G)}$	reversed only

It is evident that a solution of one or the other type always exists. When $R_G > R_L$ a normal section always exists, and when $R_G < R_L$ a reversed one exists. The MATLAB function `lmatch` implements Eqs. (12.11.3). Its usage is as follows:

```
X12 = lmatch(ZG,ZL,type); % L-section matching
```

where `type` takes on the string values 'n' or 'r' for a normal or reversed *L*-section. The two possible solutions for X_1, X_2 are returned in the rows of the 2×2 matrix X_{12} .

Example 12.11.1: Design an *L*-section matching network for the conjugate match of the load impedance $Z_L = 100 + 50j$ ohm to the generator $Z_G = 50 + 10j$ ohm at 500 MHz. Determine the capacitance or inductance values for the matching network.

Solution: The given impedances satisfy the last of the four conditions of Eq. (12.11.6). Therefore, only a reversed *L*-section will exist. Its two solutions are:

$$X_{12} = \text{lmatch}(50 + 10j, 100 + 50j, 'r') = \begin{bmatrix} 172.4745 & -71.2372 \\ -72.4745 & 51.2372 \end{bmatrix}$$

The first solution has a capacitive $X_2 = -71.2372$ and an inductive $X_1 = 172.4745$. Setting $X_2 = 1/j\omega C$ and $X_1 = j\omega L$, where $\omega = 2\pi f = 2\pi 500 \cdot 10^6$ rad/sec, we determine the corresponding values of C and L to be $C = 4.47$ pF and $L = 54.90$ nH.

The second solution has an inductive $X_2 = 51.2372$ and a capacitive $X_1 = -72.4745$. Setting $X_2 = j\omega L$ and $X_1 = 1/j\omega C$, we find in this case, $L = 16.3$ nH and $C = 4.39$ pF. Of the two solutions, the one with the smaller values is generally preferred. \square

12.12 Pi-Section Lumped Reactive Matching Networks

Although the L -section network can match an arbitrary load to an arbitrary source, its bandwidth and Q -factor are fixed uniquely by the values of the load and source impedances through Eqs. (12.11.3).

The Π -section network, shown together with its T -section equivalent in Fig. 12.12.1, has an extra degree of freedom that allows one to control the bandwidth of the match. In particular, the bandwidth can be made as narrow as desired.

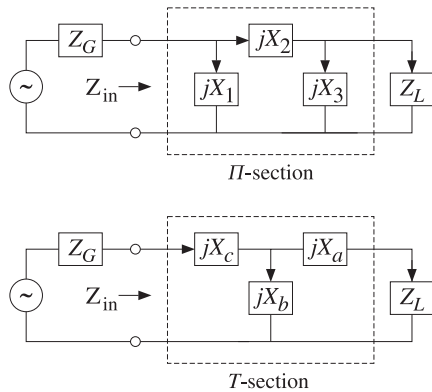

Fig. 12.12.1 Π - and T -section matching networks.

The Π , T networks (also called Δ , Y networks) can be transformed into each other by the following standard impedance transformations, which are cyclic permutations of each other:

$$Z_a = \frac{Z_2 Z_3}{U}, \quad Z_b = \frac{Z_3 Z_1}{U}, \quad Z_c = \frac{Z_1 Z_2}{U}, \quad U = Z_1 + Z_2 + Z_3$$

$$Z_1 = \frac{V}{Z_a}, \quad Z_2 = \frac{V}{Z_b}, \quad Z_3 = \frac{V}{Z_c}, \quad V = Z_a Z_b + Z_b Z_c + Z_c Z_a$$

(12.12.1)

Because Z_1, Z_2, Z_3 are purely reactive, $Z_1 = jX_1, Z_2 = jX_2, Z_3 = jX_3$, so will be Z_a, Z_b, Z_c , with $Z_a = jX_a, Z_b = jX_b, Z_c = jX_c$.

The MATLAB functions `pi2t` and `t2pi` transform between the two parameter sets. The function `pi2t` takes in the array of three values $Z_{123} = [Z_1, Z_2, Z_3]$ and outputs $Z_{abc} = [Z_a, Z_b, Z_c]$, and `t2pi` does the reverse. Their usage is:

```
Zabc = pi2t(Z123); % Pi to T transformation
Z123 = t2pi(Zabc); % T to Pi transformation
```

One of the advantages of T networks is that often they result in more practical values for the circuit elements; however, they tend to be more lossy [44,45].

Here we discuss only the design of the Π matching network. It can be transformed into a T network if so desired. Fig. 12.12.2 shows the design procedure, in which the Π network can be thought of as two L -sections arranged back to back, by splitting the series reactance X_2 into two parts, $X_2 = X_4 + X_5$.

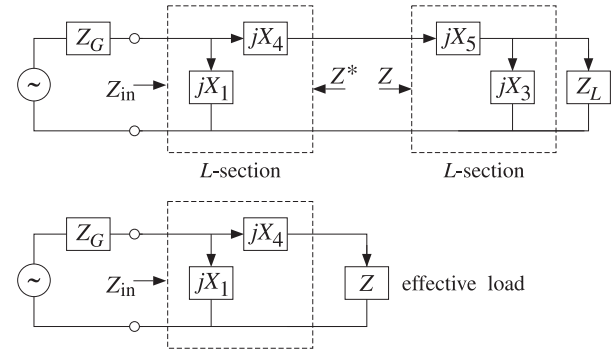

Fig. 12.12.2 Equivalent L -section networks.

An additional degree of freedom is introduced into the design by an intermediate reference impedance, say $Z = R + jX$, such that looking into the right L -section the input impedance is Z , and looking into the left L -section, it is Z^* .

Denoting the L -section impedances by $Z_1 = jX_1, Z_4 = jX_4$ and $Z_3 = jX_3, Z_5 = jX_5$, we have the conditions:

$$Z_{\text{left}} = Z_4 + \frac{Z_1 Z_G}{Z_1 + Z_G} = Z^*, \quad Z_{\text{right}} = Z_5 + \frac{Z_3 Z_L}{Z_3 + Z_L} = Z$$

(12.12.2)

As shown in Fig. 12.12.2, the right L -section and the load can be replaced by the effective load impedance $Z_{\text{right}} = Z$. Because Z_1 and Z_4 are purely reactive, their conjugates will be $Z_1^* = -Z_1$ and $Z_4^* = -Z_4$. It then follows that the first of Eqs. (12.12.2) can be rewritten as the equivalent condition:

$$Z_{\text{in}} = \frac{Z_1 (Z_4 + Z)}{Z_1 + Z_4 + Z} = Z_G^*$$

(12.12.3)

This is precisely the desired conjugate matching condition that must be satisfied by the network (as terminated by the effective load Z).

Eq. (12.12.3) can be interpreted as the result of matching the source Z_G to the load Z with a normal L -section. An equivalent point of view is to interpret the first of Eqs. (12.12.2) as the result of matching the source Z to the load Z_G using a reversed L -section.

Similarly, the second of Eqs. (12.12.2) is the result of matching the source Z^* to the load Z_L (because the input impedance looking into the right section is then $(Z^*)^* = Z$). Thus, the reactances of the two L -sections can be obtained by the two successive calls to `lmatch`:

$$\begin{aligned} X_{14} &= [X_1, X_4] = \text{lmatch}(Z_G, Z, 'n') = \text{lmatch}(Z, Z_G, 'r') \\ X_{35} &= [X_3, X_5] = \text{lmatch}(Z^*, Z_L, 'r') \end{aligned} \quad (12.12.4)$$

In order for Eqs. (12.12.4) to always have a solution, the resistive part of Z must satisfy the conditions (12.11.6). Thus, we must choose $R < R_G$ and $R < R_L$, or equivalently:

$$R < R_{\min}, \quad R_{\min} = \min(R_G, R_L) \quad (12.12.5)$$

Otherwise, Z is arbitrary. For design purposes, the nominal Q factors of the left and right sections can be taken to be the quantities:

$$Q_G = \sqrt{\frac{R_G}{R} - 1}, \quad Q_L = \sqrt{\frac{R_L}{R} - 1} \quad (12.12.6)$$

The maximum of the two is the one with the maximum value of R_G or R_L , that is,

$$Q = \sqrt{\frac{R_{\max}}{R} - 1}, \quad R_{\max} = \max(R_G, R_L) \quad (12.12.7)$$

This Q -factor can be thought of as a parameter that controls the bandwidth. Given a value of Q , the corresponding R is obtained by:

$$R = \frac{R_{\max}}{Q^2 + 1} \quad (12.12.8)$$

For later reference, we may express Q_G, Q_L in terms of Q as follows:

$$Q_G = \sqrt{\frac{R_G}{R_{\max}}(Q^2 + 1) - 1}, \quad Q_L = \sqrt{\frac{R_L}{R_{\max}}(Q^2 + 1) - 1} \quad (12.12.9)$$

Clearly, one or the other of Q_L, Q_G is equal to Q . We note also that Q may not be less than the value Q_{\min} achievable by a *single* L -section match. This follows from the equivalent conditions:

$$Q > Q_{\min} \Leftrightarrow R < R_{\min}, \quad Q_{\min} = \sqrt{\frac{R_{\max}}{R_{\min}} - 1} \quad (12.12.10)$$

The MATLAB function `pmatch` implements the design equations (12.12.4) and then constructs $X_2 = X_4 + X_5$. Because there are two solutions for X_4 and two for X_5 , we can add them in four different ways, leading to four possible solutions for the reactances of the Π network.

The inputs to `pmatch` are the impedances Z_G, Z_L and the reference impedance Z , which must satisfy the condition (12.12.10). The output is a 4×3 matrix X_{123} whose rows are the different solutions for X_1, X_2, X_3 :

$$X_{123} = \text{pmatch}(Z_G, Z_L, Z); \quad \% \Pi \text{ matching network design}$$

The analytical form of the solutions can be obtained easily by applying Eqs. (12.11.3) to the two cases of Eq. (12.12.4). In particular, if the load and generator impedances are real-valued, we obtain from (12.11.4) the following simple analytical expressions:

$$X_1 = -\epsilon_G \frac{R_G}{Q_G}, \quad X_2 = \frac{R_{\max}(\epsilon_G Q_G + \epsilon_L Q_L)}{Q^2 + 1}, \quad X_3 = -\epsilon_L \frac{R_L}{Q_L} \quad (12.12.11)$$

where ϵ_G, ϵ_L are ± 1 , Q_G, Q_L are given in terms of Q by Eq. (12.12.9), and either Q is given or it can be computed from Eq. (12.12.7). The choice $\epsilon_G = \epsilon_L = 1$ is made often, corresponding to capacitive X_1, X_3 and inductive X_2 [44,973].

As emphasized by Wingfield [44,973], the definition of Q as the maximum of Q_L and Q_G underestimates the total Q -factor of the network. A more appropriate definition is the sum $Q_o = Q_L + Q_G$.

An alternative set of design equations, whose input is Q_o , is obtained as follows. Given Q_o , we solve for the reference resistance R by requiring:

$$Q_o = Q_G + Q_L = \sqrt{\frac{R_G}{R} - 1} + \sqrt{\frac{R_L}{R} - 1}$$

This gives the solution for R , and hence for Q_G, Q_L :

$$\begin{aligned} R &= \frac{(R_G - R_L)^2}{(R_G + R_L)Q_o^2 - 2Q_o\sqrt{R_G R_L}Q_o^2 - (R_G - R_L)^2} \\ Q_G &= \frac{R_G Q_o - \sqrt{R_G R_L}Q_o^2 - (R_G - R_L)^2}{R_G - R_L} \\ Q_L &= \frac{R_L Q_o - \sqrt{R_G R_L}Q_o^2 - (R_G - R_L)^2}{R_L - R_G} \end{aligned} \quad (12.12.12)$$

Then, construct the Π reactances from:

$$X_1 = -\epsilon_G \frac{R_G}{Q_G}, \quad X_2 = R(\epsilon_G Q_G + \epsilon_L Q_L), \quad X_3 = -\epsilon_L \frac{R_L}{Q_L} \quad (12.12.13)$$

The only requirement is that Q_o be greater than Q_{\min} . Then, it can be verified that Eqs. (12.12.12) will always result in positive values for R, Q_G , and Q_L . More simply, the value of R may be used as an input to the function `pmatch`.

Example 12.12.1: We repeat Example 12.11.1 using a Π network. Because $Z_G = 50 + 10j$ and $Z_L = 100 + 50j$, we arbitrarily choose $Z = 20 + 40j$, which satisfies $R < \min(R_G, R_L)$. The MATLAB function `pmatch` produces the solutions:

$$X_{123} = [X_1, X_2, X_3] = \text{pmatch}(Z_G, Z_L, Z) = \begin{bmatrix} 48.8304 & -71.1240 & 69.7822 \\ -35.4970 & 71.1240 & -44.7822 \\ 48.8304 & 20.5275 & -44.7822 \\ -35.4970 & -20.5275 & 69.7822 \end{bmatrix}$$

All values are in ohms and the positive ones are inductive while the negatives ones, capacitive. To see how these numbers arise, we consider the solutions of the two L -sections of Fig. 12.12.2:

$$X_{14} = \text{lmatch}(Z_G, Z, 'n') = \begin{bmatrix} 48.8304 & -65.2982 \\ -35.4970 & -14.7018 \end{bmatrix}$$

$$X_{35} = \text{lmatch}(Z^*, Z_L, 'r') = \begin{bmatrix} 69.7822 & -5.8258 \\ -44.7822 & 85.825 \end{bmatrix}$$

where X_4 and X_5 are the second columns. The four possible ways of adding the entries of X_4 and X_5 give rise to the four values of X_2 . It is easily verified that each of the four solutions satisfy Eqs. (12.12.2) and (12.12.3). □

Example 12.12.2: It is desired to match a 200 ohm load to a 50 ohm source at 500 MHz. Design L -section and Π -section matching networks and compare their bandwidths.

Solution: Because $R_G < R_L$ and $X_G = 0$, only a reversed L -section will exist. Its reactances are computed from:

$$X_{12} = [X_1, X_2] = \text{lmatch}(50, 200, 'r') = \begin{bmatrix} 115.4701 & -86.6025 \\ -115.4701 & 86.6025 \end{bmatrix}$$

The corresponding minimum Q factor is $Q_{\min} = \sqrt{200/50 - 1} = 1.73$. Next, we design a Π section with a Q factor of 5. The required reference resistance R can be calculated from Eq. (12.12.8):

$$R = \frac{200}{5^2 + 1} = 7.6923 \text{ ohm}$$

The reactances of the Π matching section are then:

$$X_{123} = [X_1, X_2, X_3] = \text{pmatch}(50, 200, 7.6923) = \begin{bmatrix} 21.3201 & -56.5016 & 40 \\ -21.3201 & 56.5016 & -40 \\ 21.3201 & 20.4215 & -40 \\ -21.3201 & -20.4215 & 40 \end{bmatrix}$$

The Π to T transformation gives the reactances of the T -network:

$$X_{abc} = [X_a, X_b, X_c] = \text{pi2t}(X_{123}) = \begin{bmatrix} -469.0416 & 176.9861 & -250 \\ 469.0416 & -176.9861 & 250 \\ -469.0416 & -489.6805 & 250 \\ 469.0416 & 489.6805 & -250 \end{bmatrix}$$

If we increase, the Q to 15, the resulting reference resistance becomes $R = 0.885$ ohm, resulting in the reactances:

$$X_{123} = [X_1, X_2, X_3] = \text{pmatch}(50, 200, 0.885) = \begin{bmatrix} 6.7116 & -19.8671 & 13.3333 \\ -6.7116 & 19.8671 & -13.3333 \\ 6.7116 & 6.6816 & -13.3333 \\ -6.7116 & -6.6816 & 13.3333 \end{bmatrix}$$

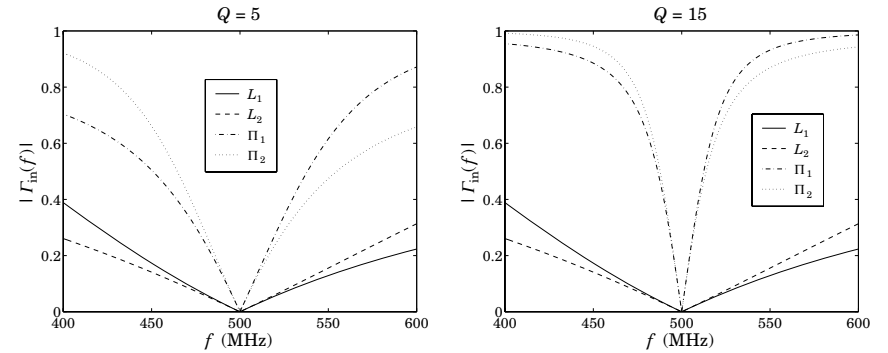

Fig. 12.12.3 Comparison of L -section and Π -section matching.

Fig. 12.12.3 shows the plot of the input reflection coefficient, that is, the quantity $\Gamma_{in} = (Z_{in} - Z_G^*) / (Z_{in} + Z_G)$ versus frequency.

If a reactance X_i is positive, it represents an inductance with a frequency dependence of $Z_i = jX_i f / f_0$, where $f_0 = 500$ MHz is the frequency of the match. If X_i is negative, it represents a capacitance with a frequency dependence of $Z_i = jX_i f_0 / f$.

The graphs display the two solutions of the L -match, but only the first two solutions of the Π match. The narrowing of the bandwidth with increasing Q is evident. □

The Π network achieves a narrower bandwidth over a single L -section network. In order to achieve a *wider* bandwidth, one may use a double L -section network [1006], as shown in Fig. 12.12.4.

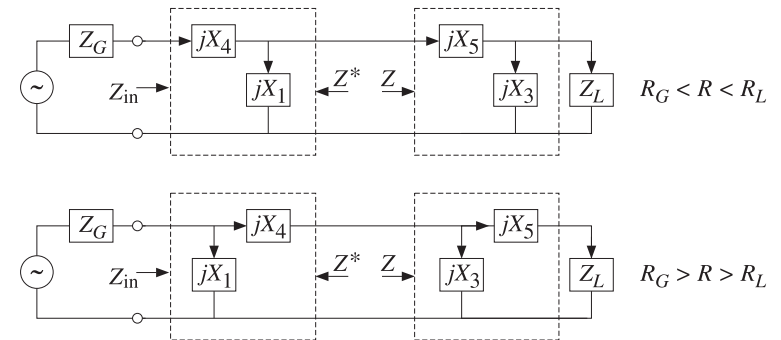

Fig. 12.12.4 Double L -section networks.

The two L -sections are either both reversed or both normal. The design is similar to Eq. (12.12.4). In particular, if $R_G < R < R_L$, we have:

$$X_{14} = [X_1, X_4] = \text{lmatch}(Z_G, Z, 'r')$$

$$X_{35} = [X_3, X_5] = \text{lmatch}(Z^*, Z_L, 'r')$$
(12.12.14)

and if $R_G > R > R_L$:

$$\begin{aligned} X_{14} &= [X_1, X_4] = \text{lmatch}(Z_G, Z, 'n') \\ X_{35} &= [X_3, X_5] = \text{lmatch}(Z^*, Z_L, 'n') \end{aligned} \tag{12.12.15}$$

The widest bandwidth (corresponding to the smallest Q) is obtained by selecting $R = \sqrt{R_G R_L}$. For example, consider the case $R_G < R < R_L$. Then, the corresponding left and right Q factors will be:

$$Q_G = \sqrt{\frac{R}{R_G} - 1}, \quad Q_L = \sqrt{\frac{R_L}{R} - 1}$$

Both satisfy $Q_G < Q_{\min}$ and $Q_L < Q_{\min}$. Because we always choose Q to be the maximum of Q_G, Q_L , the optimum Q will correspond to that R that results in $Q_{\text{opt}} = \min(\max(Q_G, Q_L))$. It can be verified easily that $R_{\text{opt}} = \sqrt{R_G R_L}$ and

$$Q_{\text{opt}} = Q_{L,\text{opt}} = Q_{G,\text{opt}} = \sqrt{\frac{R_{\text{opt}}}{R_G} - 1} = \sqrt{\frac{R_L}{R_{\text{opt}}} - 1}$$

These results follow from the inequalities:

$$\begin{aligned} Q_G &\leq Q_{\text{opt}} \leq Q_L, & \text{if } R_G < R \leq R_{\text{opt}} \\ Q_L &\leq Q_{\text{opt}} \leq Q_G, & \text{if } R_{\text{opt}} \leq R < R_L \end{aligned}$$

Example 12.12.3: Use a double L -section to widen the bandwidth of the single L -section of Example 12.12.2.

Solution: The Q -factor of the single section is $Q_{\min} = \sqrt{200/500 - 1} = 1.73$. The optimum reference resistor is $R_{\text{opt}} = \sqrt{50 \cdot 200} = 100$ ohm and the corresponding minimized optimum $Q_{\text{opt}} = 1$.

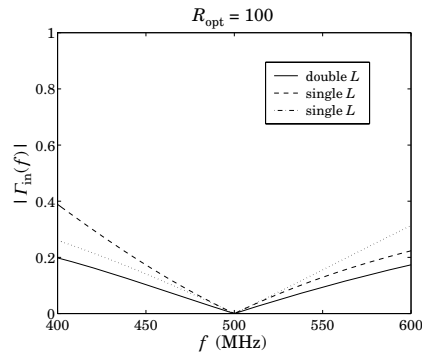

Fig. 12.12.5 Comparison of single and double L -section networks.

The reactances of the single L -section were given in Example 12.12.2. The reactances of the two sections of the double L -sections are calculated by the two calls to `lmatch`:

$$\begin{aligned} X_{14} &= [X_1, X_4] = \text{lmatch}(50, 100, 'r') = \begin{bmatrix} 100 & -50 \\ -100 & 50 \end{bmatrix} \\ X_{35} &= [X_3, X_5] = \text{lmatch}(100, 200, 'r') = \begin{bmatrix} 200 & -100 \\ -200 & 100 \end{bmatrix} \end{aligned}$$

The corresponding input reflection coefficients are plotted in Fig. 12.12.5. As in the design of the Π network, the dual solutions of each L -section can be paired in four different ways. But, for the above optimum value of R , the four solutions have virtually identical responses. There is some widening of the bandwidth, but not by much. □

12.13 Reversed Matching Networks

The types of lossless matching networks that we considered in this chapter satisfy the property that if a network is designed to transform a load impedance Z_b into an input impedance Z_a , then the reversed (i.e., flipped left-right) network will transform the load Z_a^* into the input Z_b^* . This is illustrated in Fig. 12.13.1.

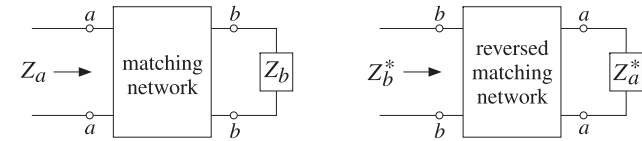

Fig. 12.13.1 Forward and reversed matching networks.

The losslessness assumption is essential. This property is satisfied only by matching networks built from segments of *lossless* transmission lines, such as stub matching or quarter-wave transformers, and by the L -, Π -, and T -section reactive networks. Some examples are shown in Fig. 12.13.2.

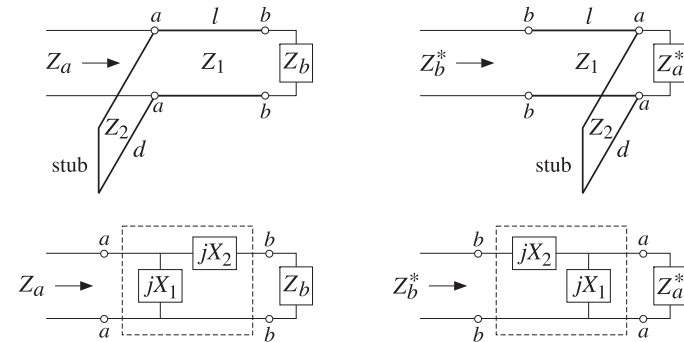

Fig. 12.13.2 Examples of reversed matching networks.

Working with admittances, we find for the stub example that the input and load admittances must be related as follows for the forward and reverse networks:

$$Y_a = Y_{\text{stub}} + Y_1 \frac{Y_b + jY_1 \tan \beta l}{Y_1 + jY_b \tan \beta l} \Leftrightarrow Y_b^* = Y_1 \frac{(Y_a^* + Y_{\text{stub}}) + jY_1 \tan \beta l}{Y_1 + j(Y_a^* + Y_{\text{stub}}) \tan \beta l} \quad (12.13.1)$$

where $Y_{\text{stub}} = -jY_2 \cot \beta d$ for a shorted parallel stub, and $Y_{\text{stub}} = jY_2 \tan \beta d$ for an opened one. The equivalence of the two equations in (12.13.1) is a direct consequence of the fact that Y_{stub} is purely reactive and therefore satisfies $Y_{\text{stub}}^* = -Y_{\text{stub}}$. Indeed, solving the left equation for Y_b and conjugating the answer gives:

$$Y_b = Y_1 \frac{(Y_a - Y_{\text{stub}}) - jY_1 \tan \beta l}{Y_1 - j(Y_a - Y_{\text{stub}}) \tan \beta l} \Rightarrow Y_b^* = Y_1 \frac{(Y_a^* - Y_{\text{stub}}^*) + jY_1 \tan \beta l}{Y_1 + j(Y_a^* - Y_{\text{stub}}^*) \tan \beta l}$$

which is equivalent to the right equation (12.13.1) because $Y_{\text{stub}}^* = -Y_{\text{stub}}$. Similarly, for the L -section example we find the conditions for the forward and reversed networks:

$$Z_a = \frac{Z_1(Z_2 + Z_b)}{Z_1 + Z_2 + Z_b} \Leftrightarrow Z_b^* = Z_2 + \frac{Z_1 Z_a^*}{Z_1 + Z_a^*} \quad (12.13.2)$$

where $Z_1 = jX_1$ and $Z_2 = jX_2$. The equivalence of Eqs. (12.13.2) follows again from the reactive conditions $Z_1^* = -Z_1$ and $Z_2^* = -Z_2$.

As we will see in Chap. 13, the reversing property is useful in designing the input and output matching networks of two-port networks, such as microwave amplifiers, connected to a generator and load with standardized impedance values such as $Z_0 = 50$ ohm. This is shown in Fig. 12.13.3.

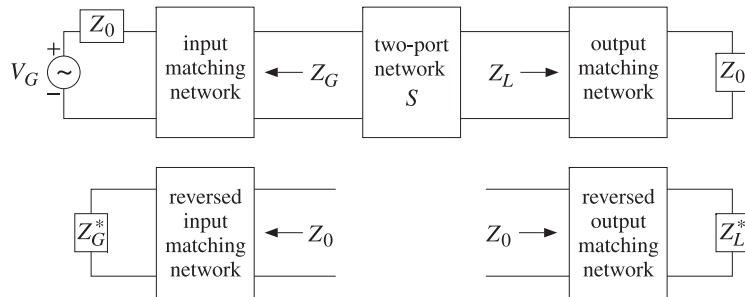

Fig. 12.13.3 Designing input and output matching networks for a two-port.

To maximize the two-port's gain or to minimize its noise figure, the two-port is required to be connected to certain optimum values of the generator and load impedances Z_G, Z_L . The output matching network must transform the actual load Z_0 into the desired value Z_L . Similarly, the input matching network must transform Z_0 into Z_G so that the two-port sees Z_G as the effective generator impedance.

In order to use the matching methods of the present chapter, it is more convenient first to design the reversed matching networks transforming a load Z_L^* (or Z_G^*) into the standardized impedance Z_0 , as shown in Fig. 12.13.3. Then the designed reversed networks may be reversed to obtain the actual matching networks. Several such design examples will be presented in Chap. 13.

12.14 Problems

12.1 A one-section quarter-wavelength transformer matching a resistive load Z_L to a line Z_0 must have characteristic impedance $Z_1 = \sqrt{Z_0 Z_L}$. Show that the reflection response Γ_1 into the main line (see Fig. 12.3.1) is given as a function of frequency by:

$$\Gamma_1 = \frac{\rho(1 + e^{-2j\delta})}{1 + \rho^2 e^{-2j\delta}}, \quad \rho = \frac{\sqrt{Z_L} - \sqrt{Z_0}}{\sqrt{Z_L} + \sqrt{Z_0}}, \quad \delta = \frac{\pi f}{2 f_0}$$

where f_0 is the frequency at which the transformer length is a quarter wavelength. Show that the magnitude-squared of Γ_1 is given by:

$$|\Gamma_1|^2 = \frac{e^{2\cos^2 \delta}}{1 + e^{2\cos^2 \delta}}, \quad e = \frac{2|\rho|}{1 - \rho^2}$$

Show that the bandwidth (about f_0) over which the voltage standing-wave ratio on the line remains less than S is given by:

$$\sin\left(\frac{\pi \Delta f}{4 f_0}\right) = \frac{(S - 1)(1 - \rho^2)}{4|\rho|\sqrt{S}}$$

12.2 Design a one-section quarter-wavelength transformer that will match a 200-ohm load to a 50-ohm line at 100 MHz. Determine the impedance Z_1 and the bandwidth Δf over which the SWR on the line remains less than $S = 1.2$.

12.3 A transmission line with characteristic impedance $Z_0 = 100 \Omega$ is terminated at a load impedance $Z_L = 150 + j50 \Omega$. What percentage of the incident power is reflected back into the line?

In order to make the load reflectionless, a short-circuited stub of length l_1 and impedance also equal to Z_0 is inserted in parallel at a distance l_2 from the load. What are the smallest values of the lengths l_1 and l_2 in units of the wavelength λ that make the load reflectionless?

12.4 A loss-free line of impedance Z_0 is terminated at a load $Z_L = Z_0 + jX$, whose resistive part is matched to the line. To properly match the line, a short-circuited stub is connected across the main line at a distance of $\lambda/4$ from the load, as shown below. The stub has characteristic impedance Z_0 .

Find an equation that determines the length l of the stub in order that there be no reflected waves into the main line. What is the length l (in wavelengths λ) when $X = Z_0$? When $X = Z_0/\sqrt{3}$?

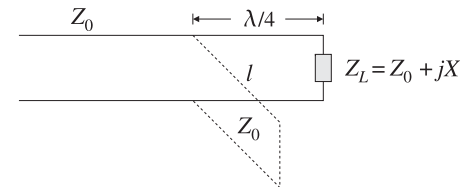

12.5 A transmission line with characteristic impedance Z_0 must be matched to a purely resistive load Z_L . A segment of length l_1 of another line of characteristic impedance Z_1 is inserted at a distance l_0 from the load, as shown in Fig. 12.7.1 (with $Z_2 = Z_0$ and $l_2 = l_0$.)

Take $Z_0 = 50, Z_1 = 100, Z_L = 80 \Omega$ and let β_0 and β_1 be the wavenumbers within the segments l_0 and l_1 . Determine the values of the quantities $\cot(\beta_1 l_1)$ and $\cot(\beta_0 l_0)$ that would guarantee matching. Show that the widest range of resistive loads Z_L that can be matched using the given values of Z_0 and Z_1 is: $12.5 \Omega < Z_L < 200 \Omega$.

- 12.6 A transmission line with resistive impedance Z_0 is terminated at a load impedance $Z_L = R + jX$. Derive an expression, in terms of Z_0 , R , X , for the proportion of the incident power that is reflected back into the line.

In order to make the load reflectionless, a short-circuited stub of length l_1 and impedance Z_0 is inserted at a distance l_2 from the load. Derive expressions for the smallest values of the lengths l_1 and l_2 in terms of the wavelength λ and Z_0 , R , X , that make the load reflectionless.

- 12.7 It is required to match a lossless transmission line Z_0 to a load Z_L . To this end, a quarter-wavelength transformer is connected at a distance l_0 from the load, as shown below. Let λ_0 and λ be the operating wavelengths of the line and the transformer segment.

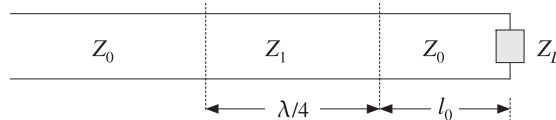

Assume $Z_0 = 50 \Omega$. Verify that the required length l_0 that will match the complex load $Z_L = 40 + 30j \Omega$ is $l_0 = \lambda/8$. What is the value of Z_1 in this case?

- 12.8 It is required to match a lossless transmission line of impedance $Z_0 = 75 \Omega$ to the complex load $Z_L = 60 + 45j \Omega$. To this end, a quarter-wavelength transformer is connected at a distance l_0 from the load, as shown in the previous problem. Let λ_0 and λ be the operating wavelengths of the line and the transformer segment.

What is the required length l_0 in units of λ_0 ? What is the characteristic impedance Z_1 of the transformer segment?

- 12.9 Show that the solution of the one-section series impedance transformer shown in Fig. 12.7.3 is given by Eq. (12.7.9), provided that either of the inequalities (12.7.10) is satisfied.
- 12.10 Show that the solution to the double-stub tuner is given by Eq. (12.10.1) and (12.10.2).
- 12.11 Match load impedance $Z_L = 10 - 5j \text{ ohm}$ of Example 12.8.1 to a 50-ohm line using a double-stub tuner with stub separation of $l = \lambda/16$. Show that a double-stub tuner with separation of $l = \lambda/8$ cannot match this load.
- 12.12 Match the antenna and feed line of Example 12.7.2 using a double stub tuner with stub separation of $l = \lambda/8$. Plot the corresponding matched reflection responses. Repeat when l is near $\lambda/2$, say, $l = 0.495 \lambda$, and compare the resulting notch bandwidths.
- 12.13 Show that the load impedance of Problem 12.11 can be matched with a triple-stub tuner using shorted stubs with separations of $l_1 = l_2 = \lambda/8$, shorted stubs. Use the smallness parameter values of $e = 0.9$ and $e = 0.1$.
- 12.14 Match the antenna and feed line of Example 12.7.2 using a stub tuner and plot the corresponding matched reflection responses. Use shorted stubs with separations $l_1 = l_2 = \lambda/8$, and the two smallness parameters $e = 0.9$ and $e = 0.7$.
- 12.15 Design an L -section matching network that matches the complex load impedance $Z_L = 30 + 40j \text{ ohm}$ to a 50-ohm transmission line. Verify that both a normal and a reversed L -section can be used.
- 12.16 It is desired to match a line with characteristic impedance Z_0 to a complex load $Z_L = R_L + jX_L$. In order to make the load reflectionless, a quarter-wavelength section of impedance Z_1 is inserted between the main line and the load, and a $\lambda/8$ or $3\lambda/8$ short-circuited stub of impedance Z_2 is inserted in parallel at the end of the line, as shown below.

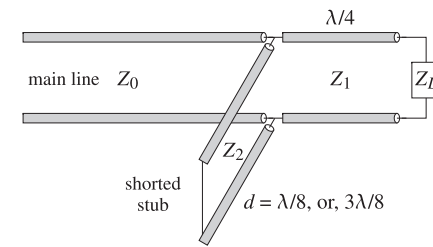

- a. Show that the section characteristic impedances must be chosen as:

$$Z_1 = \sqrt{Z_0 R_L}, \quad Z_2 = Z_0 \frac{R_L}{|X_L|}$$

Such segments are easily implemented with microstrip lines.

- b. Depending on the sign of X_L , decide when one should use a $\lambda/8$ or a $3\lambda/8$ stub.
- c. The above scheme works if both R_L and X_L are non-zero. What should we do if $R_L \neq 0$ and $X_L = 0$? What should we do if $R_L = 0$ and $X_L \neq 0$?
- d. Repeat the above questions if an open-circuited stub is used.

- 12.17 A 50-ohm transmission line is terminated at the load impedance:

$$Z_L = 40 + 80j \Omega$$

- a. In order to make the load reflectionless, a quarter-wavelength transformer section of impedance Z_1 is inserted between the line and the load, and a $\lambda/8$ or $3\lambda/8$ short-circuited stub of impedance Z_2 is inserted in parallel with the load.

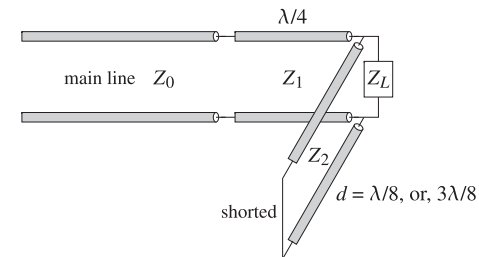

Determine the characteristic impedances Z_1 and Z_2 and whether the parallel stub should have length $\lambda/8$ or $3\lambda/8$.

- b. In the general case of a shorted stub, show that the matching conditions are equivalent to the following relationship among the quantities Z_0 , Z_L , Z_1 , Z_2 :

$$Z_L = \frac{Z_0 Z_1^2 Z_2^2 \pm j Z_2 Z_1^4}{Z_0^2 Z_2^2 + Z_1^4}$$

where Z_0 , Z_1 , Z_2 are assumed to be lossless. Determine which \pm sign corresponds to $\lambda/8$ or $3\lambda/8$ stub length.

- 12.18 An FM antenna operating at a carrier frequency of $f_0 = 100$ MHz has input impedance of $Z_L = 112.5$ ohm. The antenna is to be matched to a $Z_0 = 50$ ohm feed line with a quarter-wavelength transformer inserted as shown below.

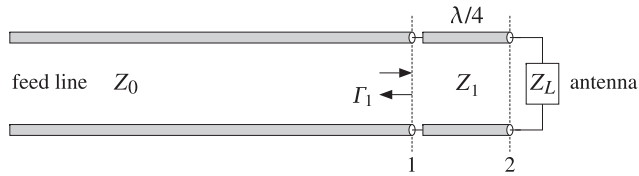

- Determine the quarter-wavelength segment's impedance Z_1 .
- Show that the reflection response back into the feed line at the left end of the quarter-wavelength transformer is given as a function of frequency by:

$$\Gamma_1(f) = \frac{\rho(1 + e^{-2j\delta})}{1 + \rho^2 e^{-2j\delta}}, \quad \delta = \frac{\pi f}{2f_0}, \quad \rho = \frac{Z_1 - Z_0}{Z_1 + Z_0}$$

- Plot $|\Gamma_1(f)|$ versus f in the range $0 \leq f \leq 200$ MHz.
- Using part (b), show that the bandwidth Δf_a about the carrier frequency f_0 that corresponds to a prescribed value $|\Gamma_a|^2$ of the reflection response is given by:

$$\Delta f_a = \frac{2f_0}{\pi} \arccos\left(\frac{2\rho^2 - |\Gamma_a|^2(1 + \rho^4)}{2\rho^2(1 - |\Gamma_a|^2)}\right)$$

- Calculate this bandwidth for the value $|\Gamma_a| = 0.1$ and determine the left and right bandedge frequencies in MHz, and place them on the above graph of $|\Gamma_1(f)|$.
- The FCC stipulates that FM radio stations operate within a 200 kHz bandwidth about their carrier frequency. What is the maximum value of the reflection response $|\Gamma_a|$ for such a bandwidth?

- 12.19 The same FM antenna is to be matched using a single-stub tuner as shown below, using an open-ended stub.

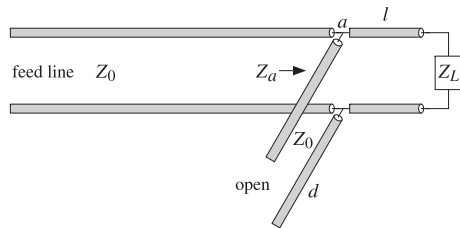

- Determine the segment lengths d, l (in cm) assuming the segments have characteristic impedance of $Z_0 = 50$ ohm and that the velocity factor on all the lines is 0.8.
- Calculate and plot versus frequency the reflection response $|\Gamma_a(f)|$ into the feed line, at the terminals a shown in the figure.