

Backscatter Morse Leaf Sensor for Agricultural Wireless Sensor Networks

Spyridon Nektarios Daskalakis¹, Ana Collado¹, Apostolos Georgiadis¹, Manos M. Tentzeris²,

¹School of Engineering & Physical Sciences, Heriot-Watt University, Edinburgh, UK

²School of Electrical and Computer Engineering, Georgia Institute of Technology, Atlanta, GA, USA

Abstract—A significant cause of low production in agriculture is the absence of water in soil. The measurement of moisture level of plants is a basic parameter and in order to calculate it, we can quantify the difference between the leaf temperature and the air temperature. In this work, we introduce a novel leaf temperature sensor for agricultural monitoring. The sensor communicates remotely with a reader using backscatter bistatic standards. It is based on a sensor board, a low power microcontroller and a RF front-end for communication. The communication part exploits backscatter Morse code modulation on a 868 MHz carrier emitter signal.

Index Terms—Agricultural, backscatter, internet-of-things (IoT), radio frequency (RF) identification (RFID) sensors, software-defined radio (SDR), morse code.

I. INTRODUCTION

In recent years, wireless sensor networks (WSN) are the enabling technology for productive and accurate farming. Precision agriculture has the benefit of providing real time feed-back on various distinctive yields and site factors. This allows the precise delivery for amounts of water, fertilizer, etc. The information related with gathering and observing significant parameters of the crops, results also to higher yields and lower cost with less effect to the environment. For example, environmental parameters such as soil moisture, relative humidity and temperature offer the ability to provide continuous feedback of microclimate conditions [1]. The WSN system requires a centralized control unit, communication gateways (if it is necessary) and the most important, the sensor nodes/tags. The elimination of wires provides significant cost savings.

One way to detect the plants moisture is to measure the soil moisture and the other is to quantify the difference between the leaf temperature T_{leaf} and the air temperature T_{air} . With a final goal to gather dependable estimations of water stress (plants moisture), the measurements should be gathered specifically from the plant and not from the soil (i.e soil moisture) or into the air (i.e relative humidity), because only the plant itself reacts simultaneously to the soil and weather conditions. Real-time measurements from leaf-air temperature difference can show when the plant needs water, from the plant itself. Recent work, based on this type of measurements [2], shows that the difference $T_{\text{leaf}} - T_{\text{air}}$ is directly related with the rainfall events.

Sensors that are generally used in agriculture purposes [3] are mainly restricted by extremely high cost, and high power consumption (batteries replacement). Sensors using wireless communication based on backscatter concept have

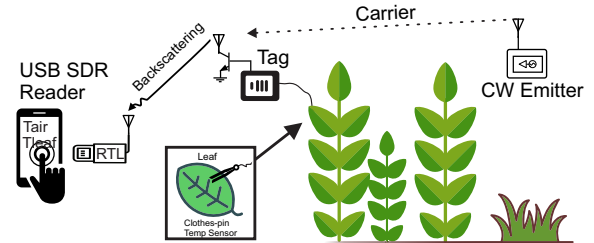

Fig. 1. Backscatter communication. Plant-leaf differential temperature ($T_{\text{leaf}} - T_{\text{air}}$) is measured by the tag and is sent back to a low cost RTL-SDR reader. Information is modulated using classic Morse coding.

been proposed in order to solve that restrictions. For example simplifying the communication part into a single RF switch/transistor and an antenna, each sensor node can measure and send information to a base station (reader) wirelessly. In the recent literature [4], soil moisture sensors were proposed and the measurements were sent to a software-defined radio (SDR) reader. Sensors have been deployed with extended ranges low power and low cost. In work [5], radio frequency identification (RFID) reader has been considered as potential RF power source and it is simultaneously used for power supply and communication with sensor.

In this work we present a novel tag-sensor node for leaf temperature measurements using the backscatter principles. The tag reflects RF signals from a carrier emitter in order to send the sensor data to a reader as shown in Fig 1. The tag consists of a microcontroller (MCU) for sensing and communication processing, a sensor board for the $T_{\text{leaf}} - T_{\text{air}}$ measurements and a FR front-end for the backscatter communication. The work is summarized as follows: in Section II, the backscatter principles are presented. In Section III, the sensor node is described. In Section IV, the low cost reader is explained and in V, an indoor lab deployment with measurements was utilized. Work is concluded in Section VI.

II. BACKSCATTER THEORY

Backscatter communication can be implemented with a RF switch, an antenna and a control unit. In RFID systems, a RF transistor changes an antenna termination load between Z_1 and Z_2 values in order to be implemented binary modulation and communication simultaneously. Generally backscatter communication is based on the multiple-antenna-load system

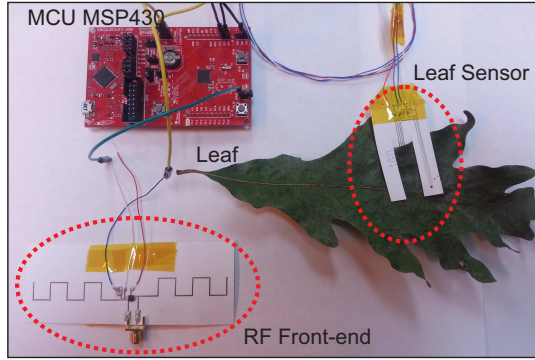

Fig. 2. Sensor node/Tag design. The tag consists of a MSP430 development board, a RF front-end (switch and antenna) and a leaf “Clothes-pin” sensor board. Sensor board and RF front-end prototypes were inkjet-printed on photo paper substrate. The tag was supplied by a super capacitor.

reflection coefficient:

$$\Gamma_i = \frac{Z_i - Z_a^*}{Z_i + Z_a^*}, \quad (1)$$

with $i = 1, 2, \dots$ and Z_a , the antenna impedance. The modulation resulting from the Γ_i change over time according to [6]. For maximization of communication efficiency the difference of Γ_1 and Γ_2 in Smith Chart must be 180 degrees. The RFID tag can communicate with a reader, by modulating its reflections of an incident continuous wave (CW) carrier, supplied by the same reader. In our case, an incident 868 MHz CW carrier is provided by a separate carrier emitter and the modulation is Morse code translation. In the next section is explained the sensor node/tag design and the modulation technique for the wireless communication.

III. TAG

The most significant part of the proposed tag is a MSP-EXP430FR5969 board (Fig. 2). Its main purpose is to collect the sensor data with an 12-bit analog to digital converter (ADC), to implement the modulation (Morse code) and to generate pulses that control the RF switch. The MCU was programmed at 1 MHz clock with low current consumption, 126 μA at 2.3 V (active mode).

The sensor board is connected with ADC and include two high precision, (± 0.1 C) analog, temperature sensors LMT70A. with current consumption per sensor, 10 μA at 2.3 V. In the left picture of Fig. 3 is depicted the schematic of sensor board and the connection pins with the MCU board. The prototype has a “clothes-pin” scheme in order to be easily fixed on a leaf (Fig. 2). The first sensor on top, measures the T_{air} and the second under the leaf surface, measures the T_{leaf} .

The RF front-end board is necessary for the wireless communication with the reader. It consists of a meander dipole antenna operating at 868 MHz and a RF switch ADG902 as is depicted in Fig. 2 and in Fig. 3, right respectively. One of the MCU output pins provides the necessary pulse waves for RF switch control.

Low cost inkjet-printing technology with nanoparticle inks and silver epoxy was used in order to fabricate the sensor

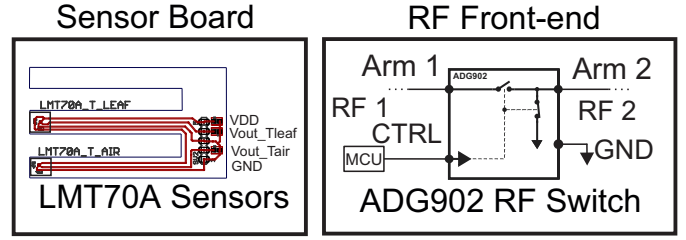

Fig. 3. Left: Sensor board schematic with low power LMT70A sensors in “Clothes-pin” design. Right: ADG902 RF switch schematic.

board and RF front-end on commercial photo paper. The tag was powered by a 0.1 F capacitor embedded in the MCU board. In future work, solar and RF energy harvesting will be used in order to charge the super capacitor [7]. The RF power will be supplied directly from the carrier emitter. If the embedded Real Time Clock (RTC) and the sleep mode of MCU is used, the duty cycle of the tag (active mode percentage of time) can be reduced. This also results to reduction of average power consumption.

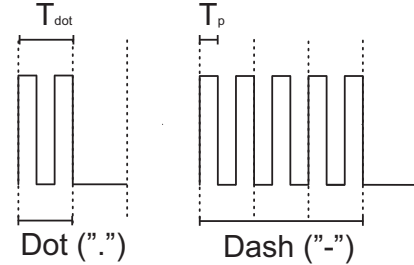

Fig. 4. Morse code symbols.

When the CW signal impinges on the dipole antenna and the RF switch states are changed between “on” and “off”, backscatter amplitude modulated signal can be created. In this work the Morse coding was implemented as modulation technique. The international Morse code technique encodes the basic Latin alphabet, and the Arabic numbers as standardized sequences of short and long signals called “dots” and “dashes” (Fig. 4). Morse code is usually used by amateur radio operators and it is first time that is used for backscatter purposes. Each letter or number is represented by a unique sequence of dots and dashes. For example, the letter “c” is translated as “dash-dot-dash-dot” (– . – .). The dot duration (T_{dot}) is the basic unit of time measurement in code transmission. The duration of a dash is three times the duration of a dot and each dot or dash is followed by a short silence, equal to T_{dot} . Between the letters we have a space equal to $3 \times T_{dot}$ (one dash), and the words are separated by a space equal to $7 \times T_{dot}$.

A Morse symbol is created due to the different state change of the switch and has frequency $1/T_p = F_{sw}$. In our work F_{sw} was fixed at 13.18 kHz. Using this frequency to control the RF switch, two new subcarrier frequencies appear in the spectrum and their frequency values are given by [8]:

$$F_{sub,1,2} = F_c \pm F_{sw} \quad (2)$$

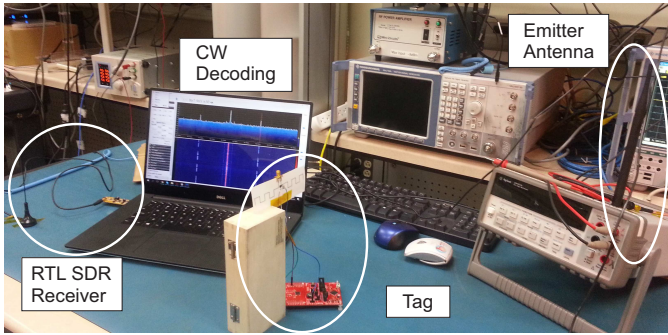

Fig. 5. Lab indoor setup without the leaf sensor. Left: USB receiver with the antenna. Middle: The tag with the RF front-end. Right: The carrier emitter antenna.

with F_c the 868 MHz carrier.

IV. READER

The sensors data were received by a low cost RTL-SDR. The dongle has the R820T radio tuner, with a 7-bit ADC and the tuning frequency range is 24 MHz to 1850 MHz. The received signal was provided directly to MATLAB software through the USB port for the software decoding. In decoding algorithm is estimated the tag's subcarrier frequency value using periodogram detection. Also power level detection was applied in order to capture the signal that contains the Morse code data (dots and dashes).

V. EXPERIMENTAL RESULTS

The proposed system (reader-tag-emitter), was tested in the lab as shown in Fig. 5. The tag was programmed to produce Morse code symbols of T_{air} measurements and the signal generator was programmed to send a 868 MHz carrier. While the distance between tag antenna and the reader was fixed at 50 cm, the SDR reader was tuned at 868 MHz with sampling rate at 250 kS/s. The MCU output signal that controls the RF switch was measured with oscilloscope and is depicted in Fig. 6. The Morse symbols “.. --- --- ..” correspond to 28°C. In Fig. 7, the transmitted symbols at the reader are presented.

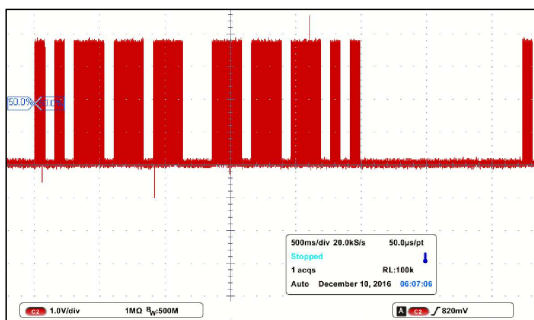

Fig. 6. Oscilloscope measurement of MCU output pin. Morse symbols “.. --- --- ..” corresponding to 28°C.

VI. CONCLUSION

In this paper, a novel Morse code backscatter tag for agricultural purposes is presented. It will be a part of WSN

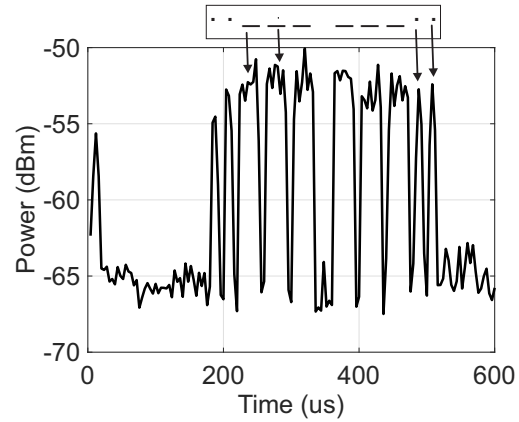

Fig. 7. Backscatter signal on time domain versus power level. Transmitted Morse symbols “.. --- --- ..” corresponding to 28°C.

that measures the water stress on plants. The sensor node has low power operation and is supplied by a super capacitor. The tags communicates wirelessly with a low cost RTL SDR receiver by backscattering RF signals from a carrier emitter. For modulation, was selected the Morse coding for simplified detection on the reader.

ACKNOWLEDGMENT

S. Daskalakis and A. Georgiadis would like to acknowledge Lloyd's Register Foundation (LRF) and the International Consortium in Nanotechnology (ICON). The work of A. Georgiadis was supported under EU H2020 Marie Skłodowska-Curie Grant Agreement 661621.

REFERENCES

- [1] L. Ruiz-Garcia, L. Lunadei, P. Barreiro, and I. Robla, “A review of wireless sensor technologies and applications in agriculture and food industry: state of the art and current trends,” *Sensors*, vol. 9, no. 6, pp. 4728–4750, Jun. 2009.
- [2] V. Palazzari, P. Mezzanotte, F. Alimenti, F. Fratini, G. Orecchini, M. Virili, C. Mariotti, and L. Roselli, “Leaf compatible “eco-friendly” temperature sensor clip for high density monitoring wireless networks,” in *Proc. IEEE 15th Medit. Microw. Symp. (MMS)*, Lecce, Italy, Dec. 2015, pp. 1–4.
- [3] C. Yu, Y. Cui, L. Zhang, and S. Yang, “Zigbee wireless sensor network in environmental monitoring applications,” in *Proc. IEEE Conf. on Wireless Commun. Networking and Mob. Comput. (WiCOM)*, Sept. 2009, pp. 1–5.
- [4] S.-N. Daskalakis, S. D. Assimonis, E. Kampianakis, and A. Bletsas, “Soil moisture scatter radio networking with low power,” *IEEE Trans. Microw. Theory Techn.*, vol. 64, no. 7, pp. 2338–2346, Jun. 2016.
- [5] A. P. Sample, D. J. Yeager, P. S. Powlledge, A. V. Mamishev, and J. R. Smith, “Design of an rfid-based battery-free programmable sensing platform,” *IEEE Trans. Instrum. Meas.*, vol. 57, no. 11, pp. 2608–2615, Jun. 2008.
- [6] J. Kimionis and M. M. Tentzeris, “Pulse shaping for backscatter radio,” in *Proc. IEEE Int. Microw. Symp. (IMS)*, San Francisco, CA, May 2016, pp. 1–4.
- [7] K. Niotaki, A. Collado, A. Georgiadis, S. Kim, and M. M. Tentzeris, “Solar/electromagnetic energy harvesting and wireless power transmission,” *Proc. IEEE*, vol. 102, no. 11, pp. 1712–1722, Nov. 2014.
- [8] G. Vannucci, A. Bletsas, and D. Leigh, “A software-defined radio system for backscatter sensor networks,” *IEEE Trans. Wireless Commun.*, vol. 7, no. 6, pp. 2170–2179, Jun. 2008.